

www.weldoninstruments.com

PROVEEDOR EXCLUSIVO:



Tracheotomy

Sinus & Hypophysectomy

Laryngo Bronchoscopy

Anaesthesia

437 - 460

Tracheotomy

Tracheotomy, Sinus & Hypophysectomy

Traqueotomia

Tracheotomie

Tracheal Dilators Forceps and Tubes | Dilataores Traqueales, Pinzas y Tubos
Trachealdilatatoren, Kropffasszangen, Trachealkanülen

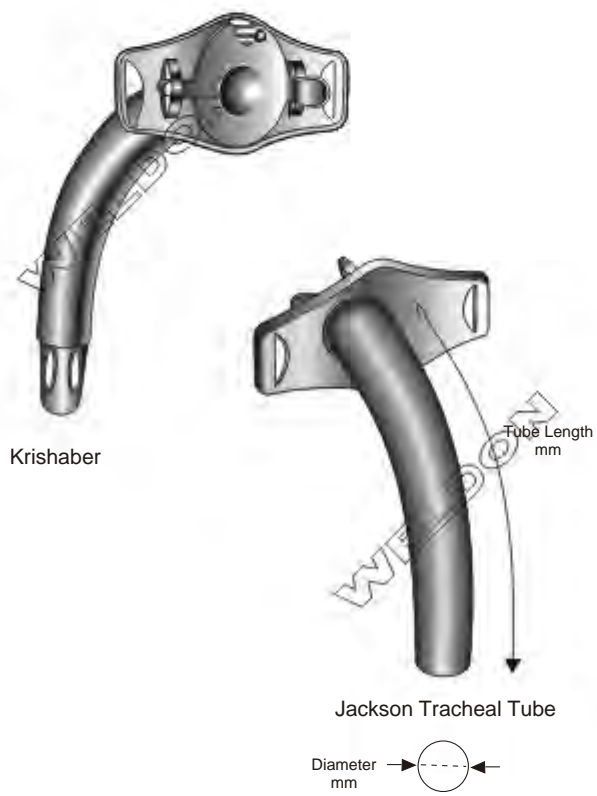
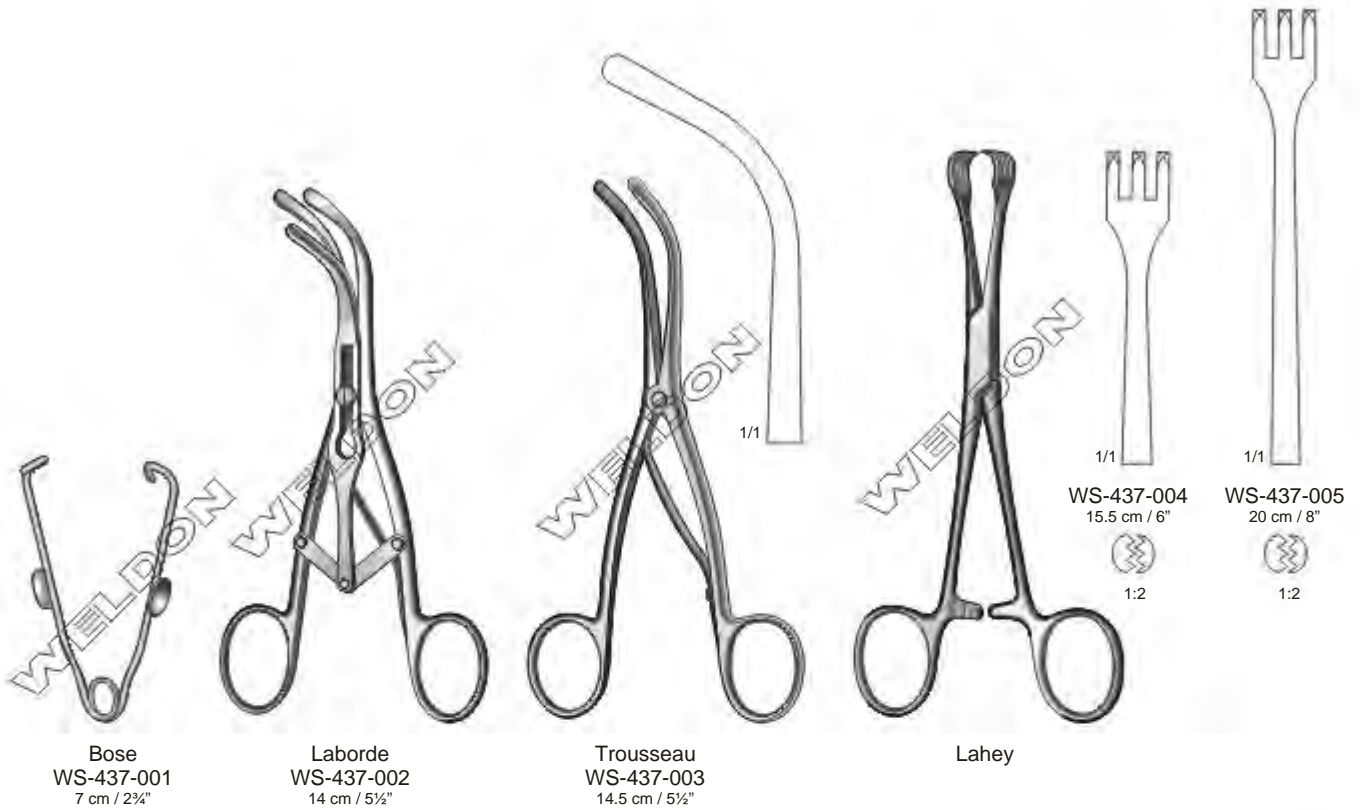

International Scale				
Tube Length mm	Diameter mm	Fig.	Krishaber	Jackson
45	4	0	WS-437-006	WS-437-016
50	5	1	WS-437-007	WS-437-017
55	6	2	WS-437-008	WS-437-018
60	7	3	WS-437-009	WS-437-019
65	8	4	WS-437-010	WS-437-020
70	9	5	WS-437-011	WS-437-021
75	10	6	WS-437-012	WS-437-022
80	11	7	WS-437-013	WS-437-023
85	12	8	WS-437-014	WS-437-024
90	13	9	WS-437-015	WS-437-025

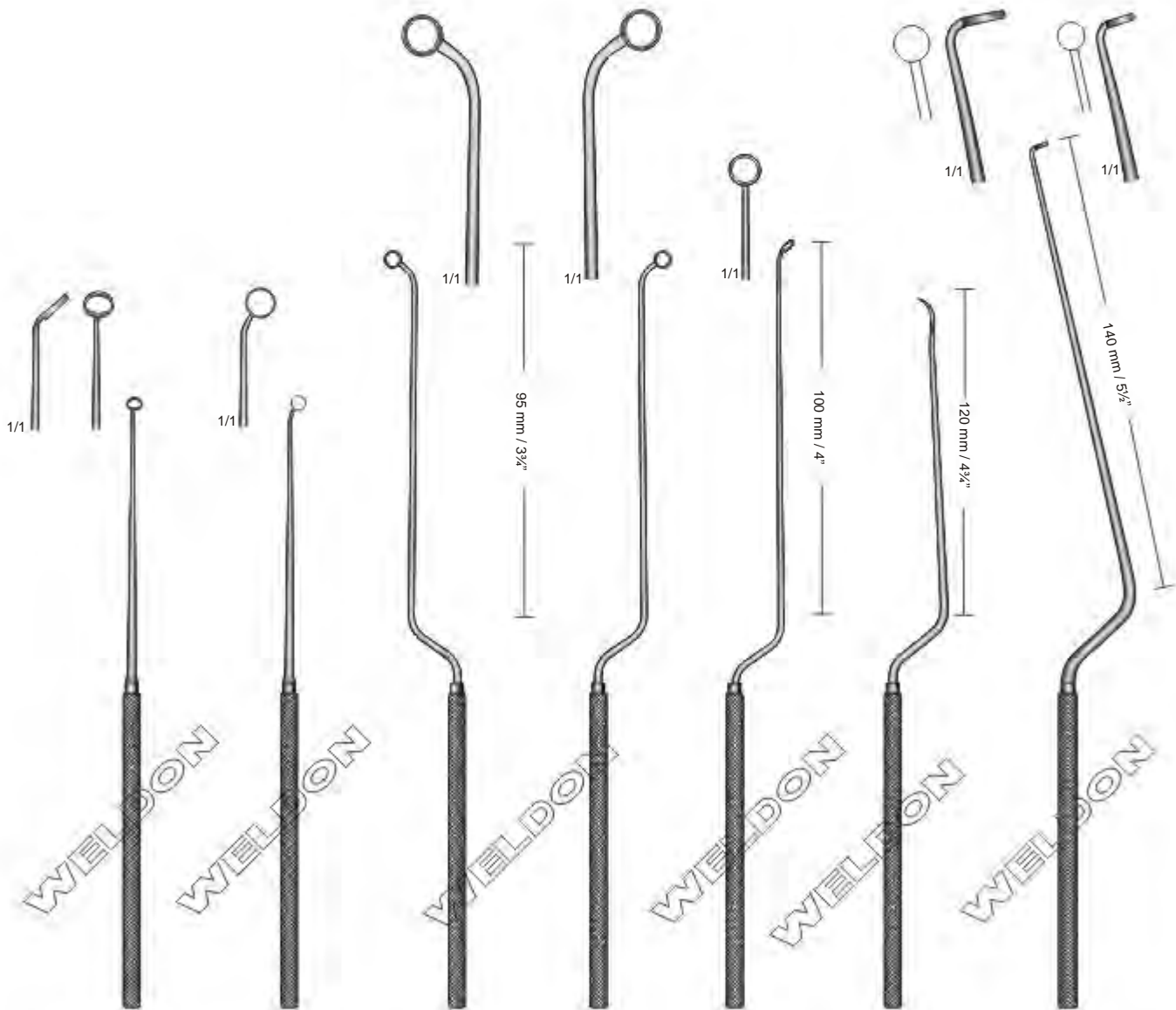

Ray
WS-438-001
 19 cm / 7 1/2"
 Ø 4 mm
 Curette, Horizontal 45°

Ray
WS-438-002
 19 cm / 7 1/2"
 Ø 4 mm
 Curette, Vertical 45°

Nicola
WS-438-003
 Ø 6.5 mm
 26 cm / 10 1/4"
 Malleable Curette
 Curved to Left

Nicola
WS-438-004
 Ø 6.5 mm
 26 cm / 10 1/4"
 Malleable Curette
 Curved to Right

Nicola
WS-438-005
 Ø 6.5 mm
 26 cm / 10 1/4"
 Malleable Curette

Nicola
WS-438-006
 21.5 cm / 8 1/2"
 Raspatory

Hardy
WS-438-007 Ø 4 mm
WS-438-008 Ø 6 mm
 26 cm / 10 1/4"
 Malleable Curette

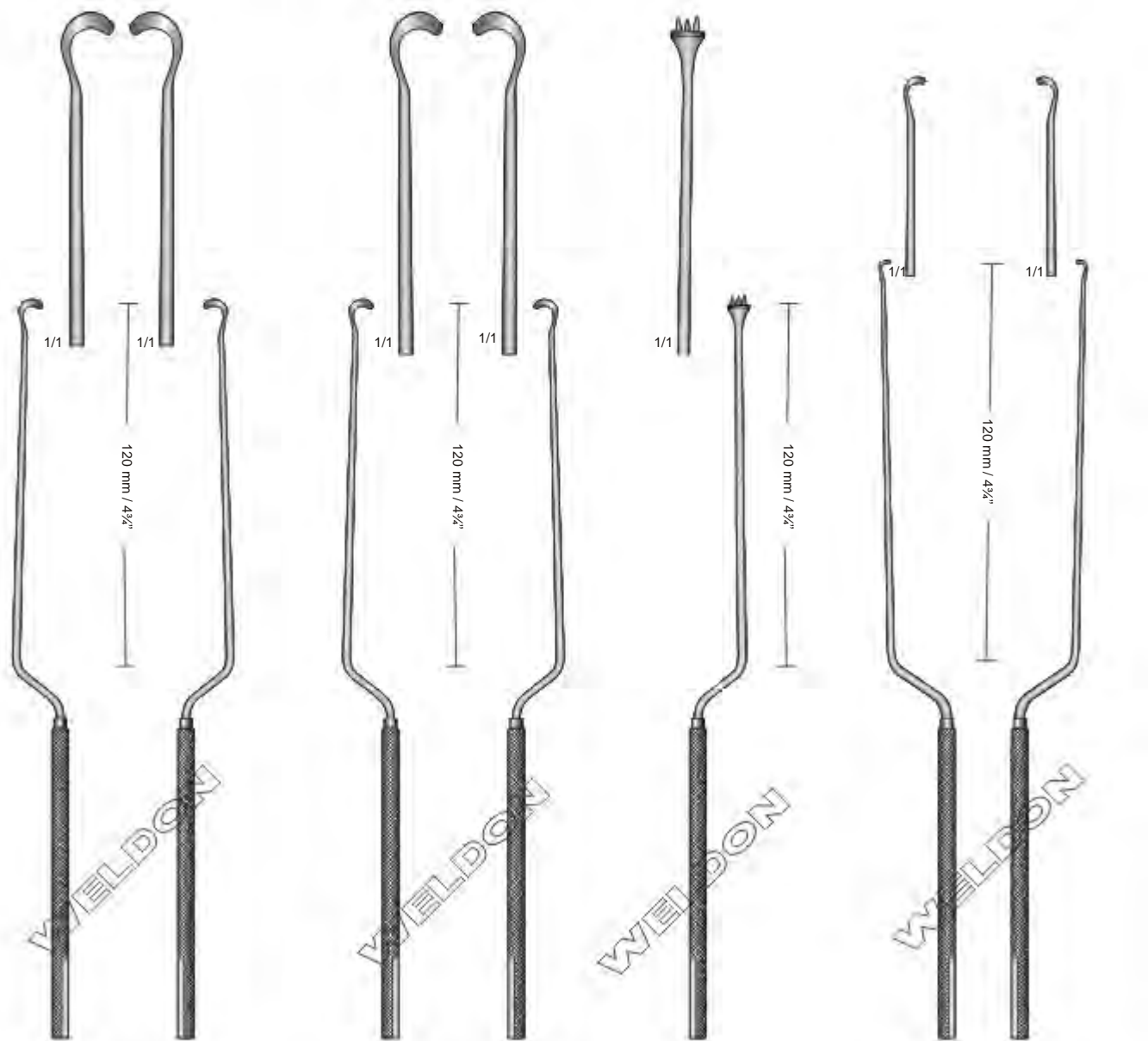

Hardy WS-439-009
21.5 cm / 8 1/2"
Curved to Left
Pituitary Enculeators
Bayonet Shaped, Blunt

Hardy WS-439-010
21.5 cm / 8 1/2"
Curved to Right

Hardy WS-439-011
21.5 cm / 8 1/2"
Curved To Left
Dissector
Sharpened Inner Edge

Hardy WS-439-012
21.5 cm / 8 1/2"
Curved To Right
Dissector

Hardy WS-439-013
21.5 cm / 8 1/2"
Pituitary Implant Fork
Bayonet Shaped

Hardy-Fahlbusch WS-439-014
24.5 cm / 8 1/2"
Curved to Left
Dissectors
Sharpened Inner Edge

Hardy-Fahlbusch WS-439-015
24.5 cm / 8 1/2"
Curved to Right
Dissectors

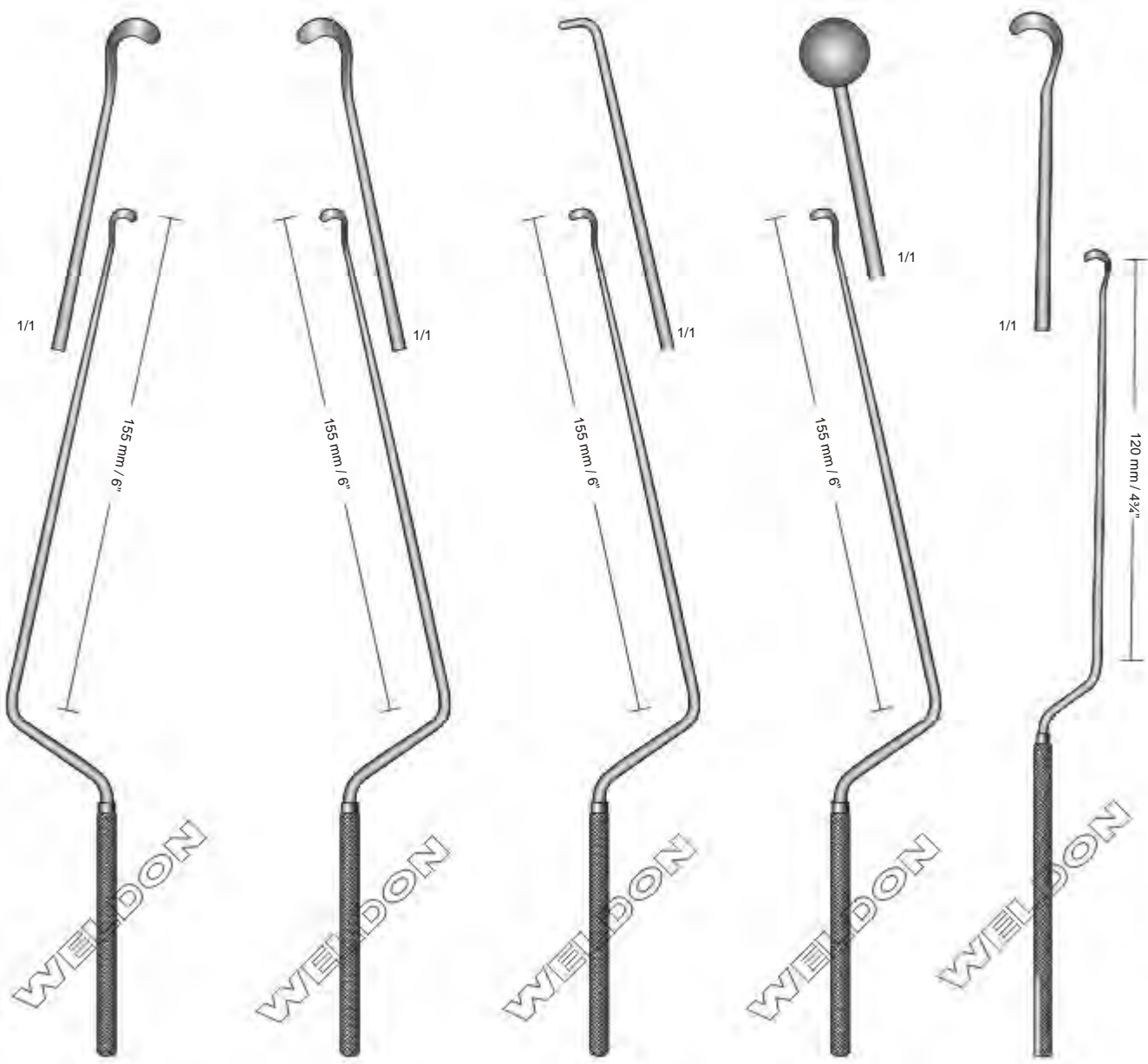

Landolt
WS-440-016
 26 cm / 10¼"
 Curved To Right
 Pituitary Enculeator
 Bayonet Shaped
 Blunt, Malleable

Landolt
WS-440-017
 26 cm / 10¼"
 Curved To Left
 Pituitary Enculeator
 Bayonet Shaped
 Blunt, Malleable

Landolt
WS-440-018
 26 cm / 10¼"
 Blunt Hook
 Bayonet Shaped
 Malleable

Landolt
WS-440-019
 26 cm / 10¼"
 Pituitary Curette
 Bayonet Shaped
 Malleable

Hardy
WS-440-020
 24.5 cm / 9½"
 Hypophysectomy
 Enculeator



Landolt-Reulen
WS-441-022
Ø 2.5 mm
26 cm / 10¼"
Curette, Rigid



Landolt-Reulen
WS-441-023
Ø 3.2 mm
26 cm / 10¼"
Raspatories, Rigid



Landolt-Reulen
WS-441-024
Ø 2.2 mm
26 cm / 10¼"
Raspatories, Rigid



Fahlbusch
WS-441-025
Ø 2.5 mm
26 cm / 10¼"
Curette, Malleable



Landolt-Reulen
WS-441-026
Ø 1.7 mm
26 cm / 10¼"
Blunt Hook, Rigid



Landolt-Reulen
WS-441-027
Ø 2 mm
26 cm / 10¼"
Dissector, Rigid

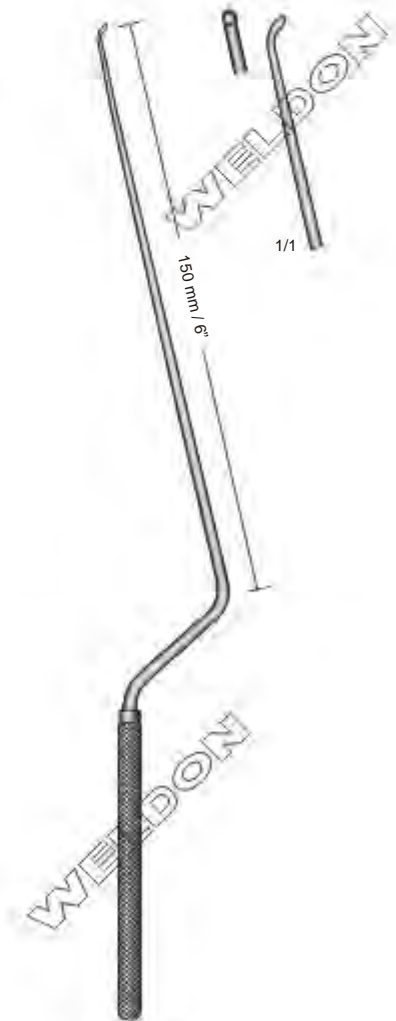

Fahlbusch
WS-441-021
26 cm / 10¼"
Scoop, Malleable

Micro Dissectors & Raspatories, Scalpel Handles | Micro Dissectores Y Legras, Mango Bisturies
 Mikro-Dissektor, Mikro Raspatorium, Skalpelli Griff



WS-442-028
 23 cm / 9"
 Micro Dissector
 Upwards Curved

WS-442-029
 23 cm / 9"
 Micro Raspatory
 Upwards Curved

Landolt
WS-442-030
 21cm / 8 1/4"
 Scalpel Handle, Bayont-Shaped
 Square Shank

Landolt
WS-442-031
 25 cm / 10"
 Scalpel Handle
 Bayont-Shaped Round

WS-442-032
 21 cm / 8 1/4"
 Scalpel Handle
 Blade Can Be Inserted
 From Both Sides
 Bayont-Shaped

Simon
WS-442-033
 20 cm / 8"
 Scalpel, Straight



1/1
WS-443-034
4.2 x 6.2 mm
Fig. 00



1/1
WS-443-035
5.2 x 7.3 mm
Fig. 0



1/1
WS-443-036
6.8 x 9.6 mm
Fig. 1

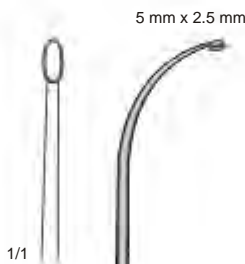

Halle
21.5 cm / 8½"
Artrum Curette
Malleable, Sharp



Mackay
WS-443-037
29 cm / 11½"
Artrum Curette
Curved Shaft
Straight End



Mackay
WS-443-038
21 cm / 8½"
Artrum Curette
Straight Shaft
Curved End



Seiffert
WS-443-039
18 cm / 7"
Ø 1mm
Salival Probe
Silver



Fisher
WS-444-040
20.5 cm / 8"



Abraham
WS-444-041
21 cm / 8 1/4"



Bruenings
WS-444-042
20.5 cm / 8"



Mackay
WS-444-043
21 cm / 8 1/2"
Artrum Sickle Knife
Straight



Carpenter
WS-445-044
 25 cm / 10"
 Tonsil Knife / Enucleator



Carpenter
WS-445-045
 24 cm / 9½"
 Tonsil Knife / Enucleator



Hajek
WS-445-046
 16.5 cm / 6½"
 3.5 mm
 Irrigation Canula
 Made of Silver



Ritter
WS-445-047 Ø 2.5 mm
WS-445-048 Ø 3 mm
WS-445-049 Ø 4 mm
WS-445-050 Ø 5 mm
 16 cm / 6¼"
 Frontal Sinus Bougies

12 mm



1/1

17 mm



1/1



10 mm

Hurd
WS-446-051
23 cm / 9"
Dissector And Pillar Retractor



1/1

Henke
WS-446-052
23 cm / 9"
Dissector And Pillar Retractor



1/1

Henke
WS-446-053
23 cm / 9"
Dissector And Pillar Retractor

Micro Scissors with Tubular Shafts, Forceps | Micro Tijeras Con Vástago Tubular, Pinzas
Mikro-Scheren mit Rohrschafe, Pinzetten

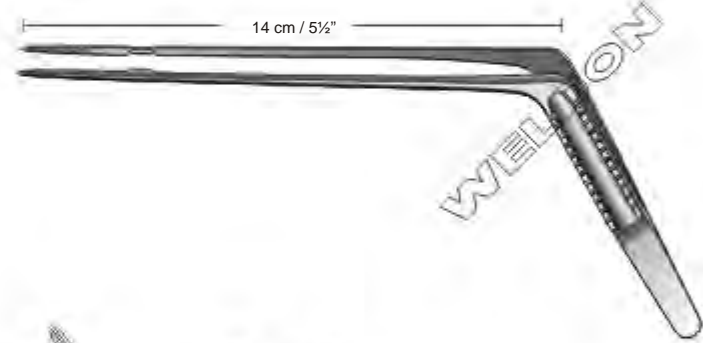
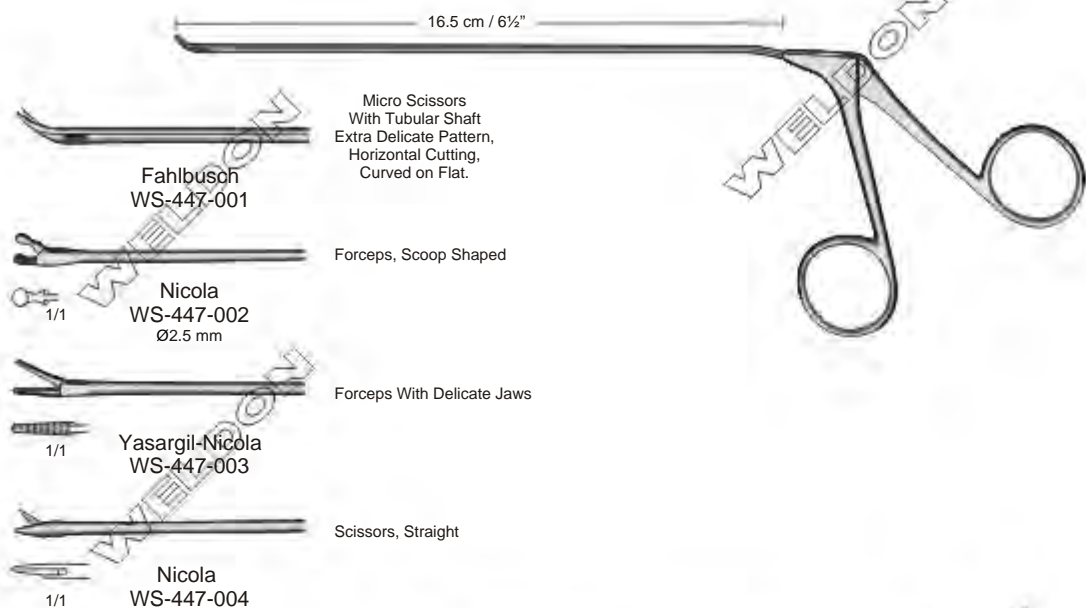

WS-447-006 18 cm / 7"
WS-447-007 23 cm / 9"

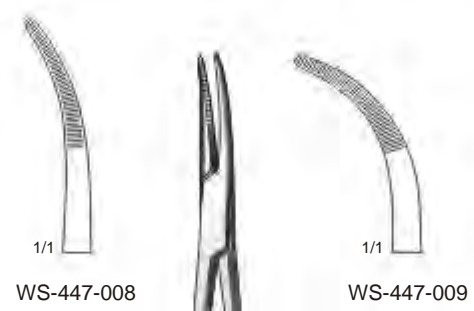

19 cm / 7½"

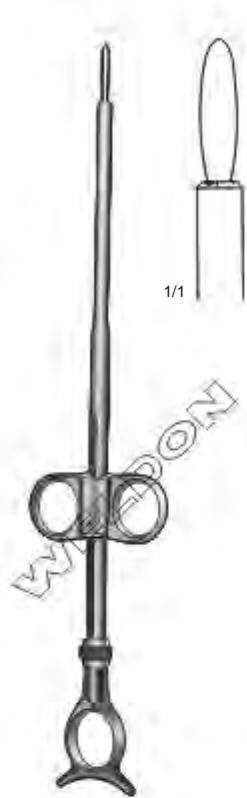
Tonsil Snares | Cierra-Nudos Para Amígdalas | Tonsillenschnürer

Eves
WS-448-001
 28 cm / 11"
 Shaft Ø 6 mm
 Without Ratchet

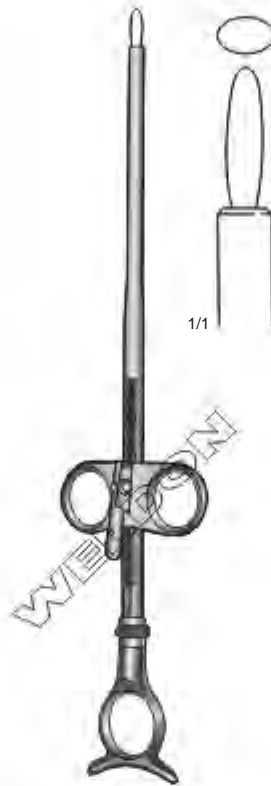

Eves
WS-448-002
 28 cm / 11"
 Shaft Ø 6 mm
 With Ratchet

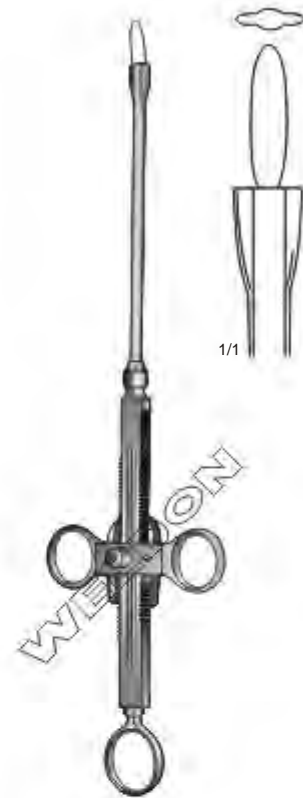

Brünings
WS-448-003
 29 cm / 11½"
 Shaft End Ø 9.5 mm
 With Double Ratchet

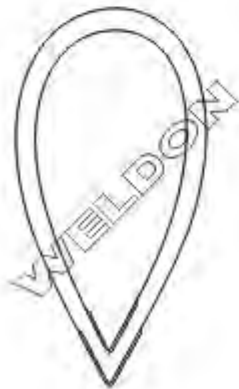

WS-448-004 40 mm
WS-448-005 50 mm
 Wire Loop
 Package of 100 Pieces



WS-448-006
 0.3 mm Ø
 Snare Wire
 Package of 100 Piece

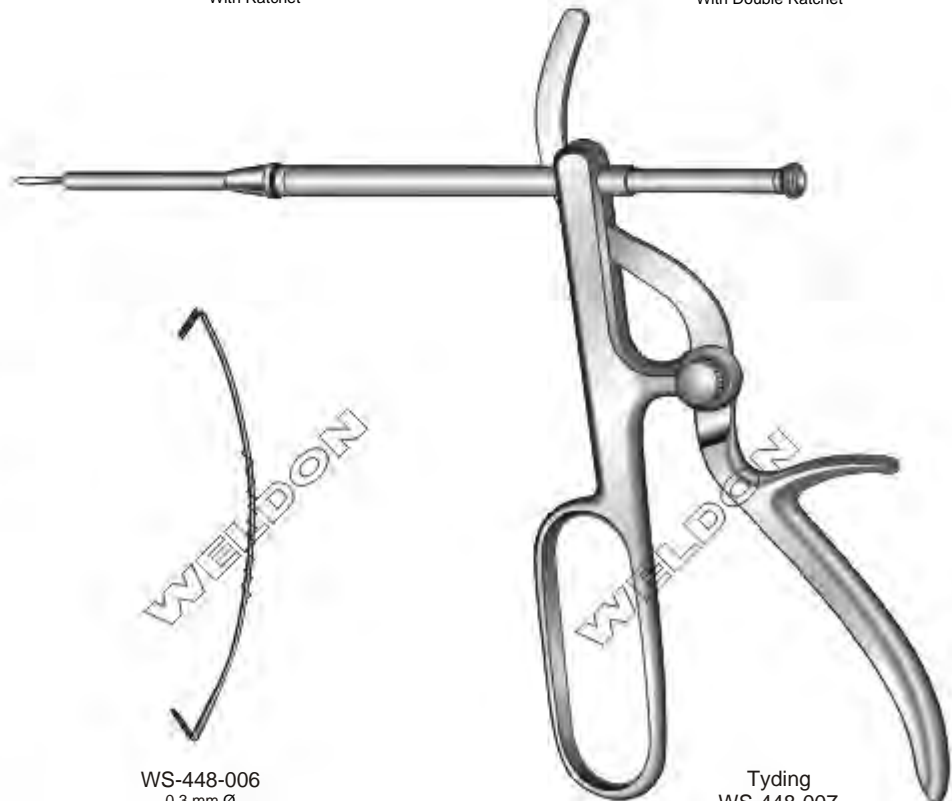

Tyding
WS-448-007
 With One Straight Tip

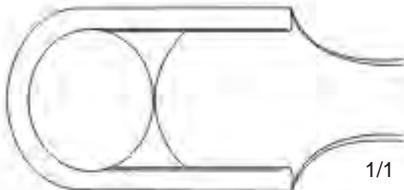

WS-449-008
18 cm / 7"
Fig. 1

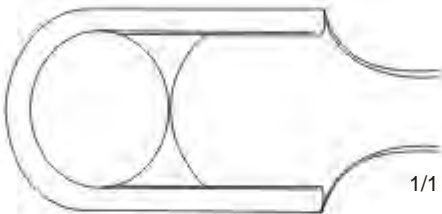

WS-449-009
22 cm / 8 3/4"
Fig. 2

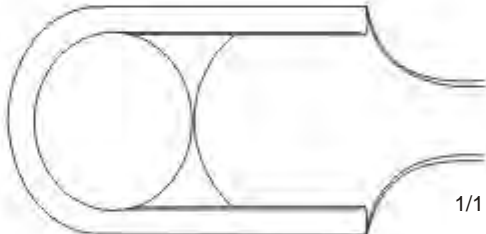

WS-449-010
26 cm / 10 1/4"
Fig. 3

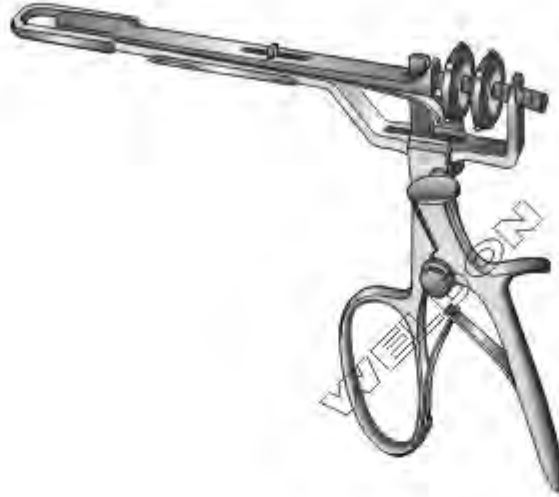

Deniel Telisectomy Forceps
Complete With 3 Tips

La Force

Hemostatic Tonsil Guillotine.

- WS-450-011 Adult Size, Round End, 24 mm Opening.
- WS-450-012 Child Size, Round End, 16 mm Opening.
- WS-450-013 Adult Size, Square End, 24 mm Opening.
- WS-450-014 Child Size, Square End, 16 mm Opening.
- WS-450-015 Cutting Blade, Adult Size, Round.
- WS-450-016 Cutting Blade, Child Size, Round.
- WS-450-017 Cutting Blade, Adult Size, Square.
- WS-450-018 Cutting Blade, Child Size, Square.



Saure

Tonsil Enucleation Guillotine, With Two Blades, One For Crushing & One For Cutting.

- WS-450-019 Small
- WS-450-020 Medium
- WS-450-021 Large
- WS-450-022 Cutting Blade Only - Small
- WS-450-023 Cutting Blade Only - Medium
- WS-450-024 Cutting Blade Only - Large

Sluder-Sauer
 Tonsil Guillotine.

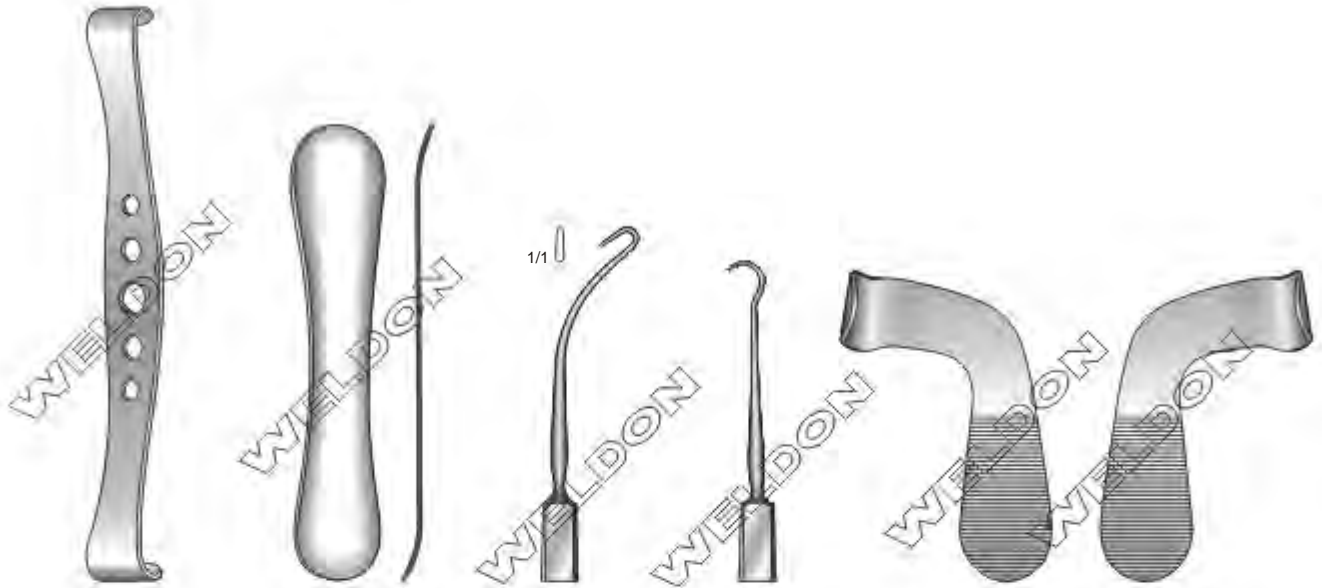
- WS-450-025 Small
- WS-450-026 Medium
- WS-450-027 Large
- WS-450-028 Blade Only - Small
- WS-450-029 Blade Only - Medium
- WS-450-030 Blade Only - Large



Berke
WS-451-001
 9 x 13 mm & 10 x 15 mm Blades
WS-451-002
 11 x 17 mm & 12 x 19 mm Blades
 Lid Everter

Jaeger
WS-451-003
 Clear Plastic
 Lid Plate

Scobee
WS-451-004
 Oblique Muscle Hook.
 Blunt Rounded Tip
 Side Curved Shank

Fink
WS-451-005
 Oblique Muscle Hook
 Sharp

Walker
WS-451-006 Right
WS-451-007 Left
 Lid Everter



Mirror With Handle
 18.5 cm / 7 1/4"

Plane Laryngeal Mirrors

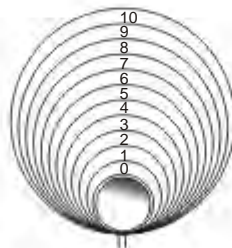

WS-451-008	Fig. 00	8 mm Ø	WS-451-020
WS-451-009	Fig. 0	10 mm Ø	WS-451-021
WS-451-010	Fig. 1	12 mm Ø	WS-451-022
WS-451-011	Fig. 2	14 mm Ø	WS-451-023
WS-451-012	Fig. 3	16 mm Ø	WS-451-024
WS-451-013	Fig. 4	18 mm Ø	WS-451-025
WS-451-014	Fig. 5	20 mm Ø	WS-451-026
WS-451-015	Fig. 6	22 mm Ø	WS-451-027
WS-451-016	Fig. 7	24 mm Ø	WS-451-028
WS-451-017	Fig. 8	26 mm Ø	WS-451-029
WS-451-018	Fig. 9	28 mm Ø	WS-451-030
WS-451-019	Fig. 10	30 mm Ø	WS-451-031
		With Handle	Without Handle

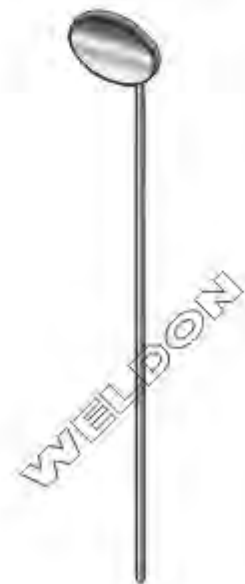

Mirror Only
 13.5 cm / 5 1/4"

Laryngeal Mirrors Handles | Espejos Laringeos y Mangos | Kehlkopfspiegel-Griffe

Shaft Length
12 cm / 4 3/4"
Without Handle

1/1
WS-452-032
Ø 6 mm
Fig. 000

1/1
WS-452-033
Ø 8 mm
Fig. 00

1/1
WS-452-034
Ø 10 mm
Fig. 0

1/1
WS-452-035
Ø 12 mm
Fig. 1

1/1
WS-452-036
Ø 14 mm
Fig. 2

1/1
WS-452-037
Ø 16 mm
Fig. 3

1/1
WS-452-038
Ø 18 mm
Fig. 4

1/1
WS-452-039
Ø 20 mm
Fig. 5

1/1
WS-452-040
Ø 22 mm
Fig. 6

1/1
WS-452-041
Ø 24 mm
Fig. 7

1/1
WS-452-042
Ø 26 mm
Fig. 8

1/1
WS-452-043
Ø 28 mm
Fig. 9

1/1
WS-452-044
Ø 30 mm
Fig. 10



WS-452-045
11 cm / 4 3/8"
With Adjustable Screw



WS-452-046
11.5 cm / 4 1/2"
With Chuck

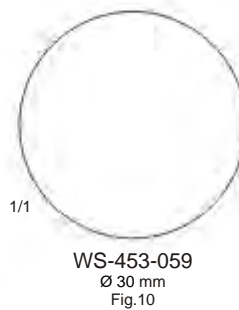
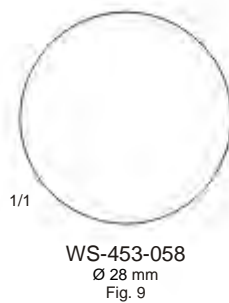
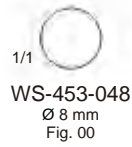





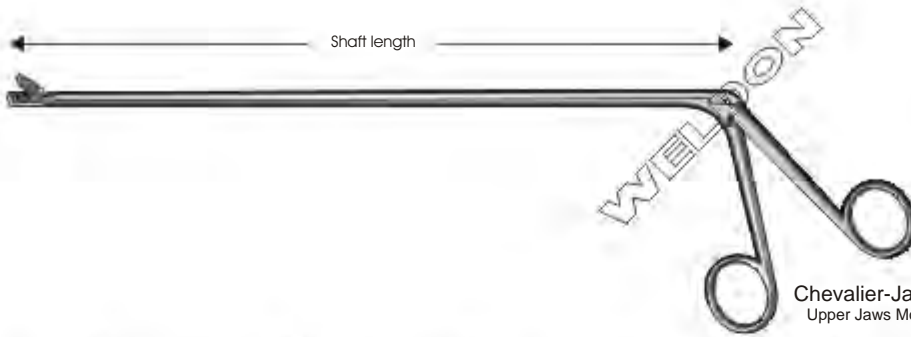

Plane
22 cm / 8³/₄"
Fixed Rhodium Handle



Michel
27 cm / 10³/₄"
Rhinoscopic Mirrors, Movable
Shaft Length
10 cm / 4"

**Broncho-Esophagoscopy Forceps | Pinzas Para Broncho-Esofagoscopia
Broncho-Oesophoskopiezangen**

Chevalier-Jackson
Upper Jaws Movable

Length		1/1
cm	Inch	
30	12	
40	16	
50	20	
60	24	

						
WS-454-001	WS-454-005	WS-454-009	WS-454-013	WS-454-017	WS-454-021	WS-454-025
WS-454-002	WS-454-006	WS-454-010	WS-454-014	WS-454-018	WS-454-022	WS-454-026
WS-454-003	WS-454-007	WS-454-011	WS-454-015	WS-454-019	WS-454-023	WS-454-027
WS-454-004	WS-454-008	WS-454-012	WS-454-016	WS-454-020	WS-454-024	WS-454-028

Huber
WS-454-029
Universal Handle
For Interchangeable Tubes & Tips

Bruenings
WS-454-030

WS-454-031	20 cm / 8"
WS-454-032	30 cm / 12"
WS-454-033	40 cm / 16"

Bruenings
WS-454-034
Laryngeal Tube, Curved
For Handles Above

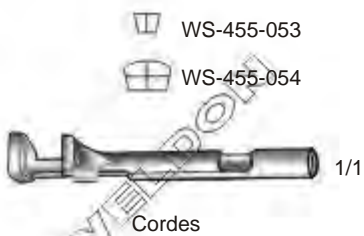
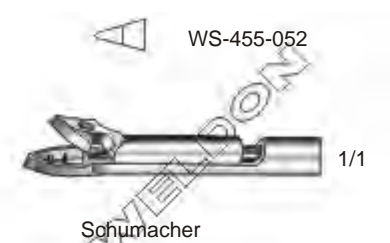
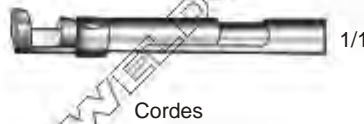
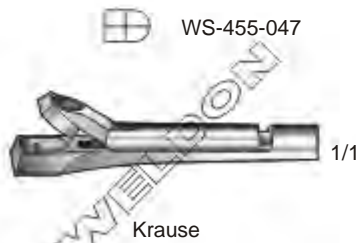
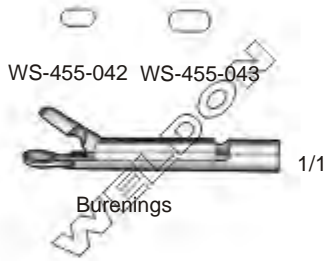
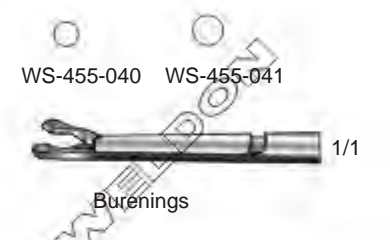
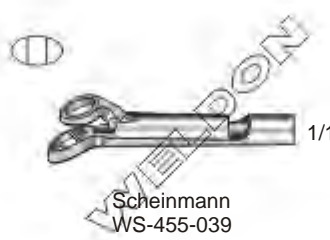



WS-456-057

17 cm / 6 3/4"

WS-456-058

20 cm / 8"

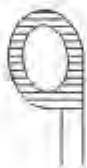

WS-456-059

25 cm / 10"



Magill
Catheter Introducing Forceps



Miller
WS-457-001
Complete Set



Miller
Fiber Optic - (Cold Light Guide Fixed)

	Fig.	Working Length (mm)
BMFI-00-45	00	45
BMFI-0-55	0	55
BMFI-1-80	1	80
BMFI-2-130	2	130
BMFI-3-170	3	170
BMFI-4-180	4	180

Re-useable



Miller
Conventional

	Fig.	Working Length (mm)
BMCI-00-45	00	45
BMCI-0-55	0	55
BMCI-1-80	1	80
BMCI-2-130	2	130
BMCI-3-170	3	170
BMCI-4-180	4	180



Miller
Fiber Optic

	Fig.	Working Length (mm)
BMSI-00-45	00	45
BMSI-0-55	0	55
BMSI-1-80	1	80
BMSI-2-130	2	130
BMSI-3-170	3	170
BMSI-4-180	4	180

Single Use



McIntosh
WS-458-001
Complete Set

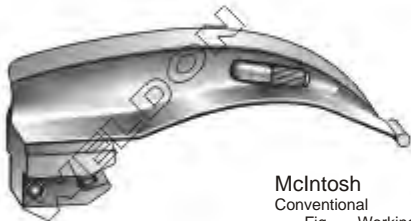

McIntosh
Conventional

	Fig.	Working Length (mm)
BMCC-0-55	0	55
BMCC-1-70	1	70
BMCC-2-78	2	78
BMCC-3-90	3	90
BMCC-4-103	4	103
BMCC-5-133	5	133
BMCC-6-150	6	150



McIntosh
Fiber Optic - (Cold Light Guide Fixed)

	Fig.	Working Length (mm)
BMFC-0-55	0	55
BMFC-1-70	1	70
BMFC-2-78	2	78
BMFC-3-90	3	90
BMFC-4-108	4	108
BMFC-5-133	5	133
BMFC-6-150	6	150

Re-Useable

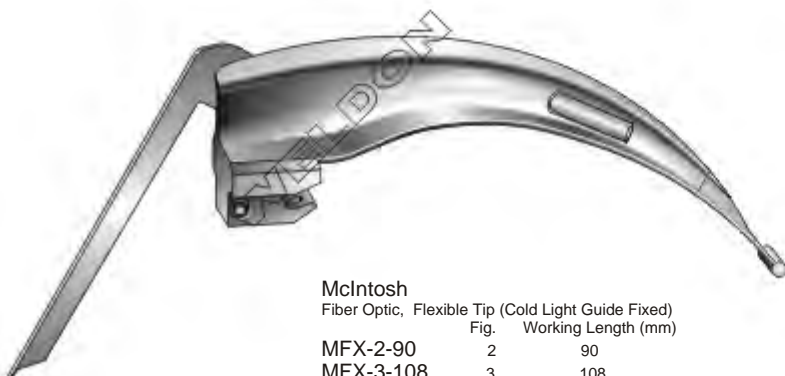

McIntosh
Fiber Optic, Flexible Tip (Cold Light Guide Fixed)

	Fig.	Working Length (mm)
MFX-2-90	2	90
MFX-3-108	3	108
MFX-4-130	4	130
MFX-5-150	5	150



McIntosh
WS-459-001
Complete Set



McIntosh
Mega Blade Fiber Optic

Fig.	Working Length (mm)
BMM-0-55	55
BMM-1-70	70
BMM-2-78	78
BMM-3-90	90
BMM-4-108	108
BMM-5-133	133
BMM-6-150	150



McIntosh
Fiber Optic

Fig.	Working Length (mm)
BMSC-0-55	55
BMSC-1-70	70
BMSC-2-78	78
BMSC-3-90	90
BMSC-4-108	108
BMSC-5-133	133
BMSC-6-150	150

Single Use



McIntosh
Flexible Tip Fiber Optic

Fig.	Working Length (mm)
MFS-2-90	90
MFS-3-108	108
MFS-4-130	130
MFS-5-150	150

Single Use



PSW-100
Pediatric Handle
Fiber Optic



PSW-200
Standard Handle
Fiber Optic



PSW-300
Standard Handle
Fiber Optic
For Mega Blade



PSW-400
Standard Handle
Conventional



PSW-500
Pediatric Handle
Conventional



PSW-600
Stubby Handle



For Conventional
Laryngoscopes Blade
(2.5 Volts)

BW-10

BW-20

BW-30

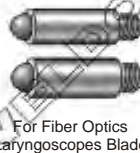

For Fiber Optics
Laryngoscopes Blade
(2.5 Volts)

BW-40

BW-50



For Mini Otoscope
Fiber Optics
(2.5 Volts)

BW-60

BW-70



For Mini Otoscope
& Ophthalmoscopes
Halogen Fiber Optics
(2.5 Volts)

BW-80

BW-90



For Mini Otoscope
Ophthalmoscopes Metal
Body Oscopes
(3 Volts)

BW-200

BW-300



For 4 Aperture
Ophthalmoscopes
(2.5 Volts)

BW-400

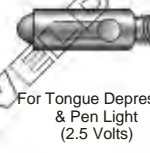

For Tongue Depressor
& Pen Light
(2.5 Volts)

BW-500



For Conventional
Mini Oscope
(2.5 Volts)

BW-100