



www.weldoninstruments.com

PROVEEDOR EXCLUSIVO:



Nasal Specula

Nasal Cutting, Tampon & Polypus Forceps

Septum Forceps & Knives

Septum Elevators, Chisels & Gouges

461 - 508

Rhinology

Rhinology
Rinologia
Rhinologie



Voltolini
5 cm / 2"



1/1
WS-461-001



1/1
WS-461-002



1/1
WS-461-003



1/1
WS-461-004

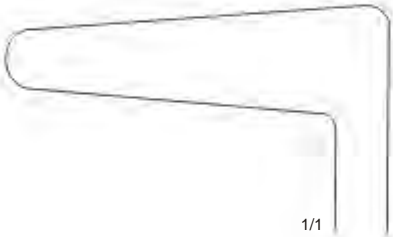

1/1
WS-461-005

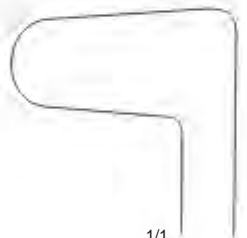

1/1
WS-461-006



Shah
7.5 cm / 3"
50 x 30 mm



Shah
7.5 cm / 3"
30 x 50 mm



1/1
WS-461-007

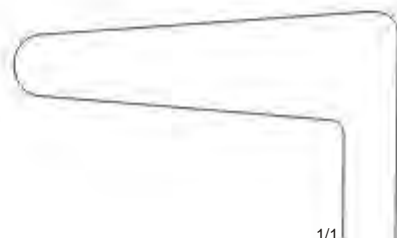

1/1
WS-461-008



WS-462-009
8.5 x 6.0
70 mm



WS-462-010
9.0 x 7.0
71 mm



WS-462-011
12.5 x 8.0
72 mm



WS-462-012
15.0 x 8.5
73 mm



WS-462-013
16.5 x 9.0
74 mm

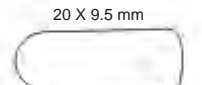

20 X 9.5 mm
WS-462-016
6.5 cm / 2½"
Fig. 1



WS-462-014
18.0 x 10.0
74 mm

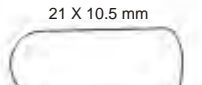

21 X 10.5 mm
WS-462-017
6.5 cm / 2½"
Fig. 2



WS-462-015
19.5 x 10.5
75 mm

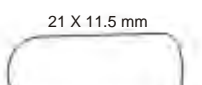

21 X 11.5 mm
WS-462-018
6.5 cm / 2½"
Fig. 3

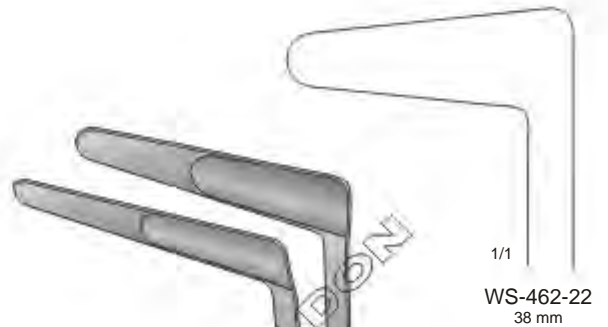
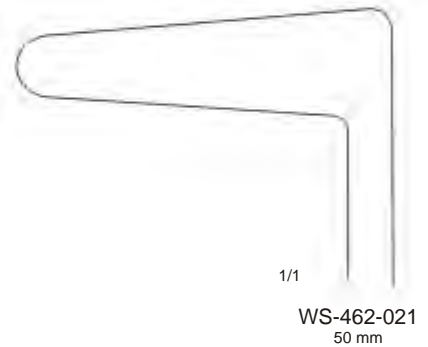
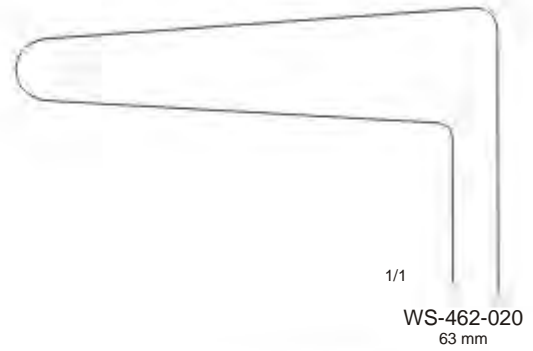
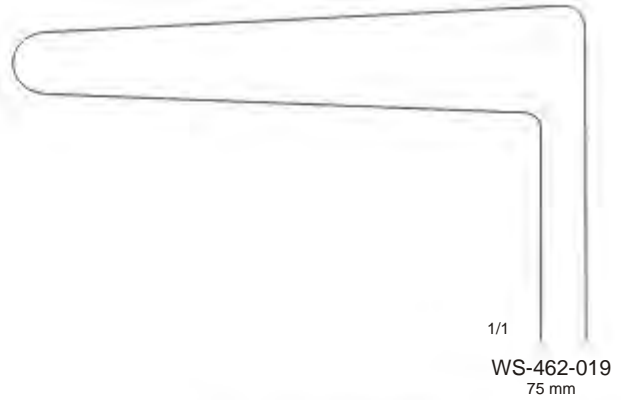
Thudichum

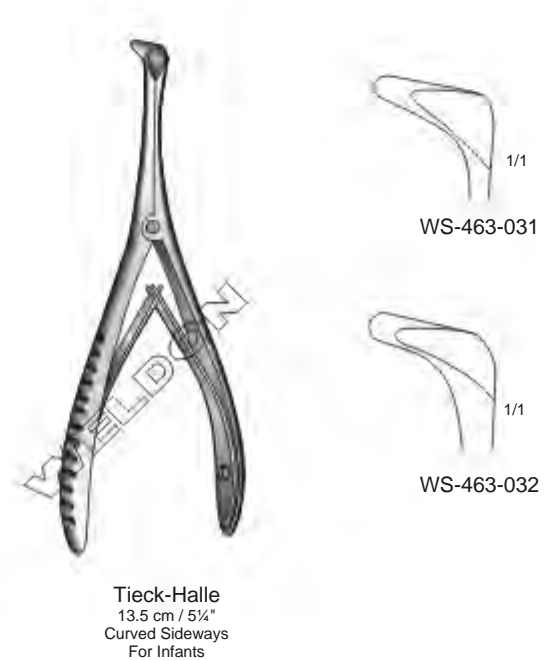
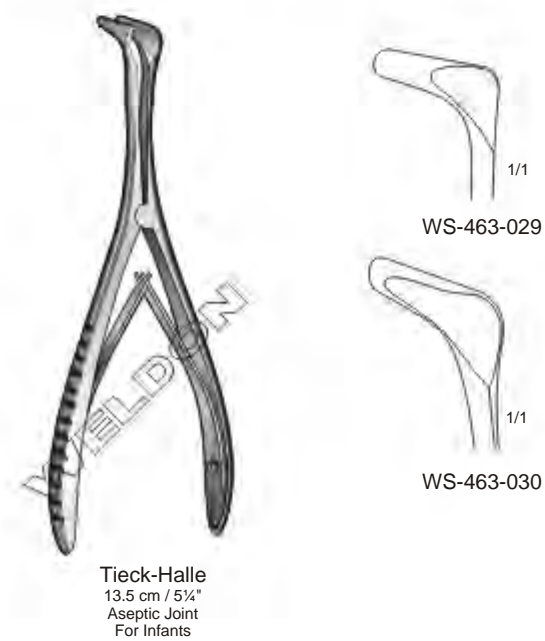
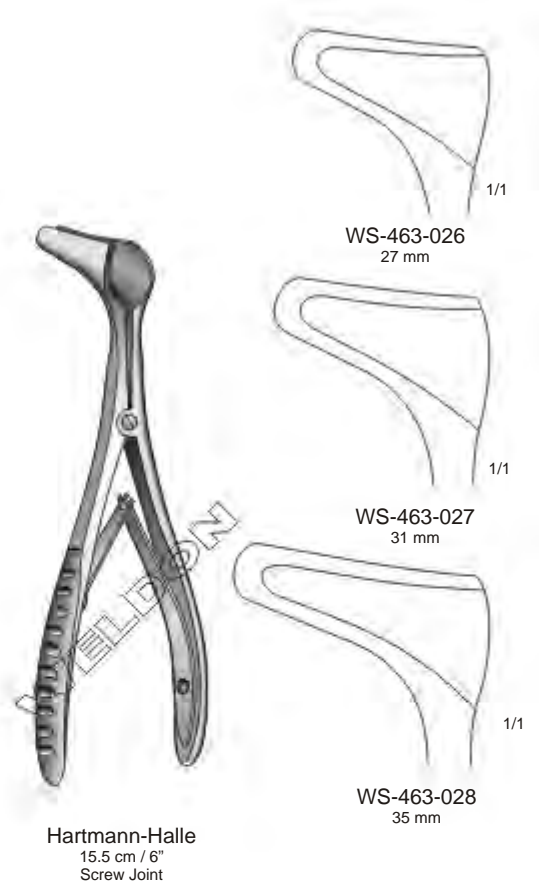
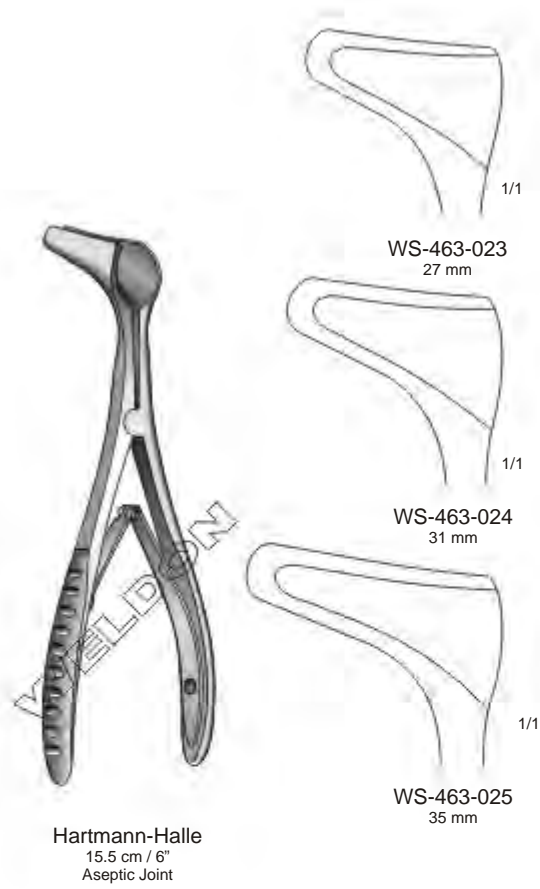
St Clair Thompson
7.3 cm / 2¾"



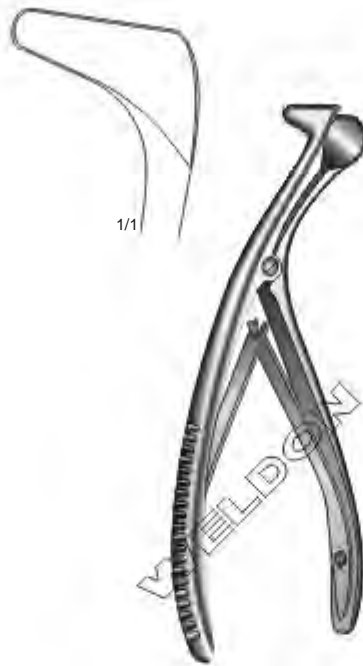

Beckmann
WS-464-033
14 cm / 5½"
Curved Sideways
For Infants



Beckmann
WS-464-034
15 cm / 6"
Curved Sideways

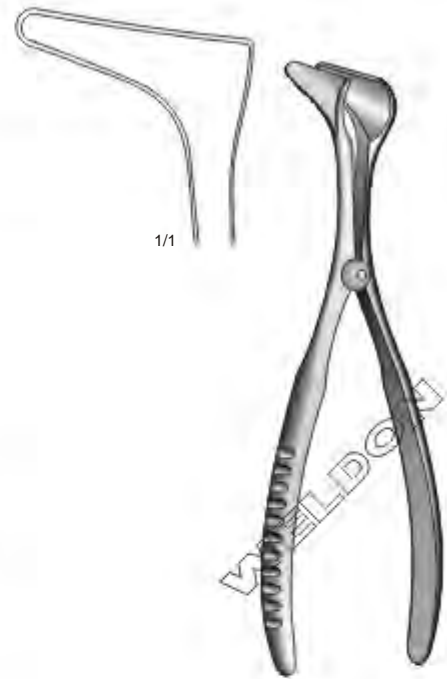

Hartmann
WS-464-035
14.5 cm / 5¾"
Light Pattern



Hartmann
16 cm / 6¼"

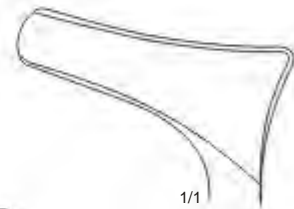

1/1
WS-464-036

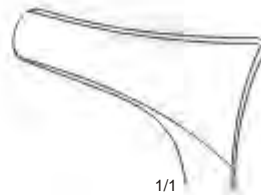

1/1
WS-464-037

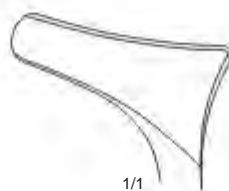

1/1
WS-464-038

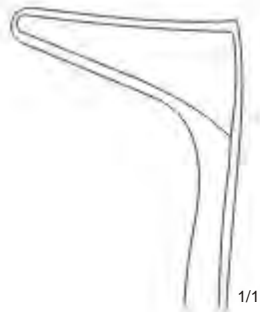

Wiener
WS-465-039
14 cm / 5½"
Small, Light Pattern



Wiener
WS-465-040
14 cm / 5½"
Medium

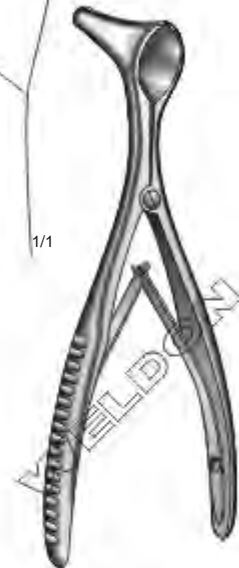
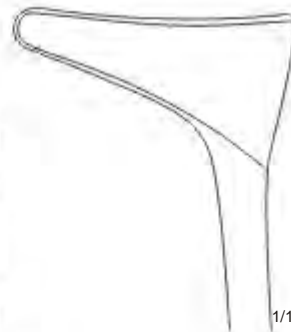

Wiener
WS-465-041
14 cm / 5½"
Large, Heavy Pattern

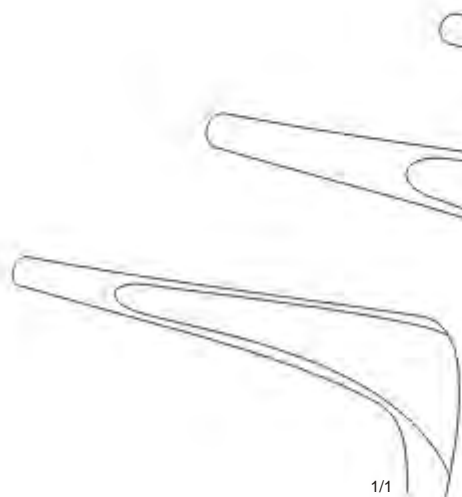

WS-465-044
41 mm
Fig. 3

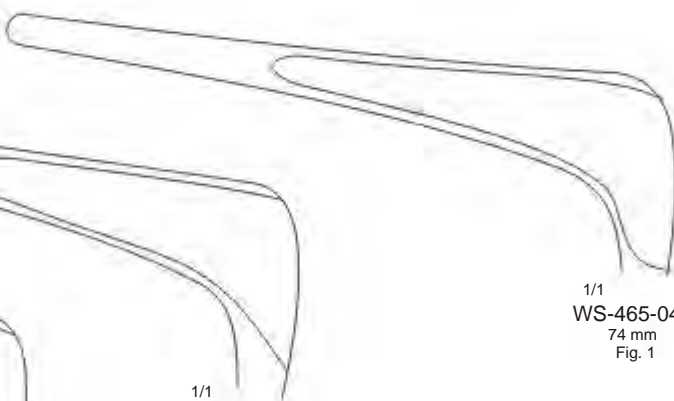

WS-465-045
60 mm
Fig. 2

1/1
WS-465-046
74 mm
Fig. 1

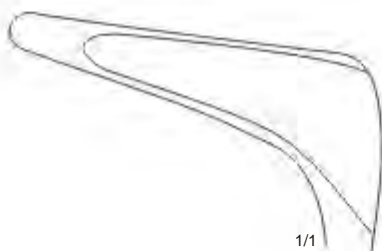

WS-465-043
38 mm
Fig. 4

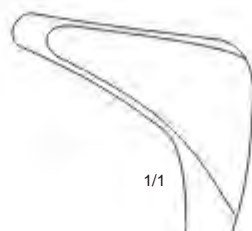

WS-465-042
20 mm
Fig. 5



Cottle
13.5 cm / 5¼"



1/1
WS-466-048
Fig.1
Infant

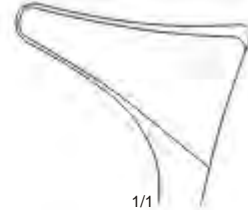

1/1
WS-466-051
Fig.1
Infant

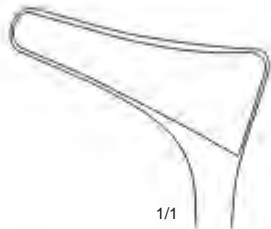

1/1
WS-466-049
Fig.2
Child

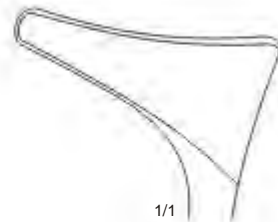

1/1
WS-466-052
Fig.2
Child

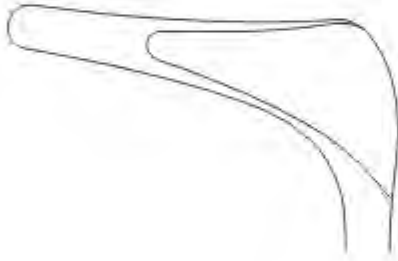

1/1
45 mm

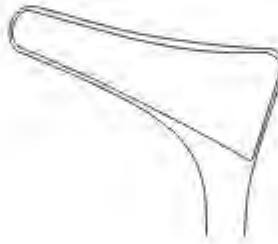

WS-466-050
Fig.3
Adult

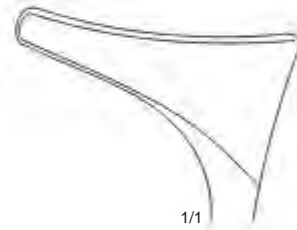

1/1
WS-466-053
Fig.3
Adult



Cottle
WS-466-047
13.5 cm / 5 1/4"
50 X 6 mm
Slightly Tapered Blades



Vienna Pattern
14.5 cm / 5 1/2"
US Style



Vienna Pattern
15 cm / 6"

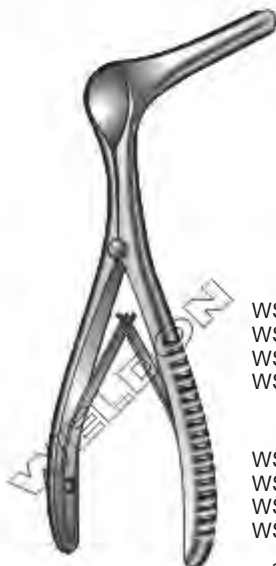
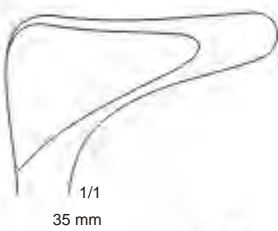
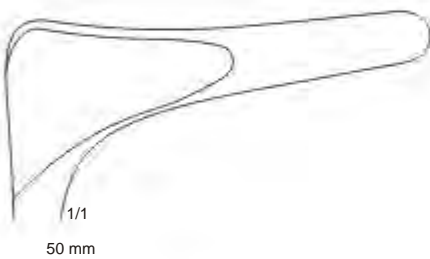
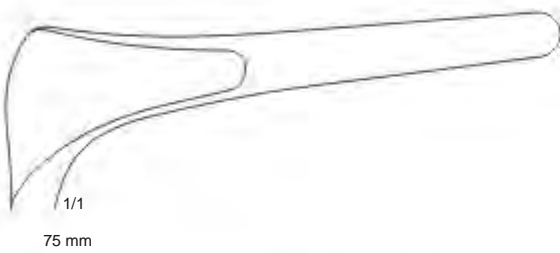
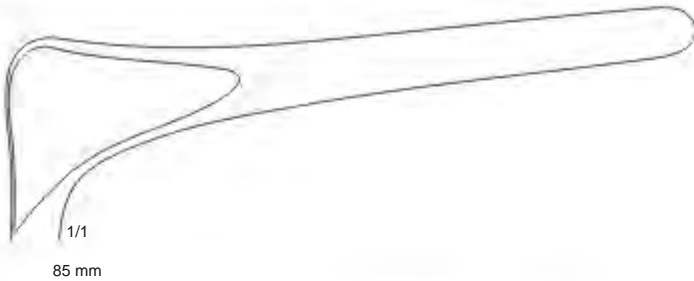

Killian
 WS-467-054 Fig. 1 36 x 7 mm
 WS-467-055 Fig. 2 56 x 7 mm
 WS-467-056 Fig. 3 75 x 7 mm
 WS-467-057 Fig. 4 90 x 7 mm
 14.5 cm / 5 7/8"
 Screw Joint

WS-467-058 Fig. 1 36 x 7 mm
 WS-467-059 Fig. 2 56 x 7 mm
 WS-467-060 Fig. 3 75 x 7 mm
 WS-467-061 Fig. 4 90 x 7 mm
 14 cm, 5 1/2"
 Septum Specula, Aseptic Joint



Yankauer
 WS-467-062
 19 cm / 7 1/2"

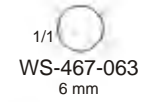

1/1
 WS-467-063
 6 mm

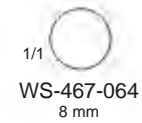

1/1
 WS-467-064
 8 mm



1/1
 WS-467-065
 10 mm



1/1
 WS-467-066
 12 mm



1/1
 WS-467-067
 14 mm



1/1
 WS-467-068
 16 mm



ST Clair Thompson
 24.5 cm / 9 3/4"
 Rhinoscopic Mirror, Bayonet

Nasal, Tampon and Polypus Forceps | Pinzas Para Taponamiento y Pólipos
 Nasentamponpinzetten, Nasenpolypenzangen



Troeltsch
 WS-468-001
 15 cm / 6"



Troeltsch
 WS-468-002
 18 cm / 7"



Gruenwald (Jansen)
 WS-468-003
 21.5 cm / 8½"



Lister
 WS-468-004
 15.5 cm / 6"



Westmacott
 WS-468-005
 20 cm / 8"



Lubet-Barbon
 WS-468-006
 18.5 cm / 7¼"
 Nasal Tampon Forceps

Nasal, Tampon and Polypus Forceps | Pinzas Para Taponamiento y Pólipos
Nasentamponpinzetten, Nasenpolypenzangen



Hartmann
WS-469-007
15 cm / 6"



Hartmann
WS-469-008
18.5 cm / 7 1/4"

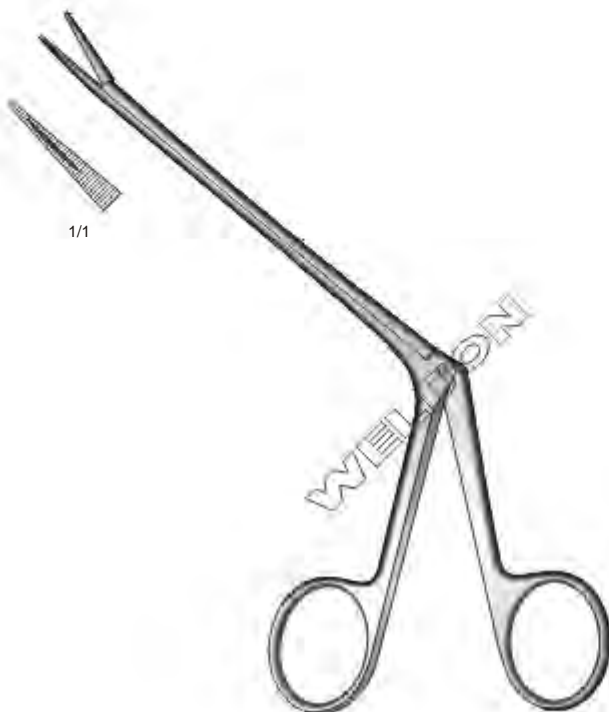

Hartmann
WS-469-009
19 cm / 7 1/2"



Tilley
WS-469-010
13.2 cm / 5 1/4"
2.20 mm

Nasal, Tampon and Polypus Forceps | Pinzas Para Taponamiento y Pólipos
Nasentamponpinzetten, Nasenpolypenzangen



Littauer
WS-470-011
18 cm / 7"



Killian
WS-470-012
17 cm / 6 3/4"

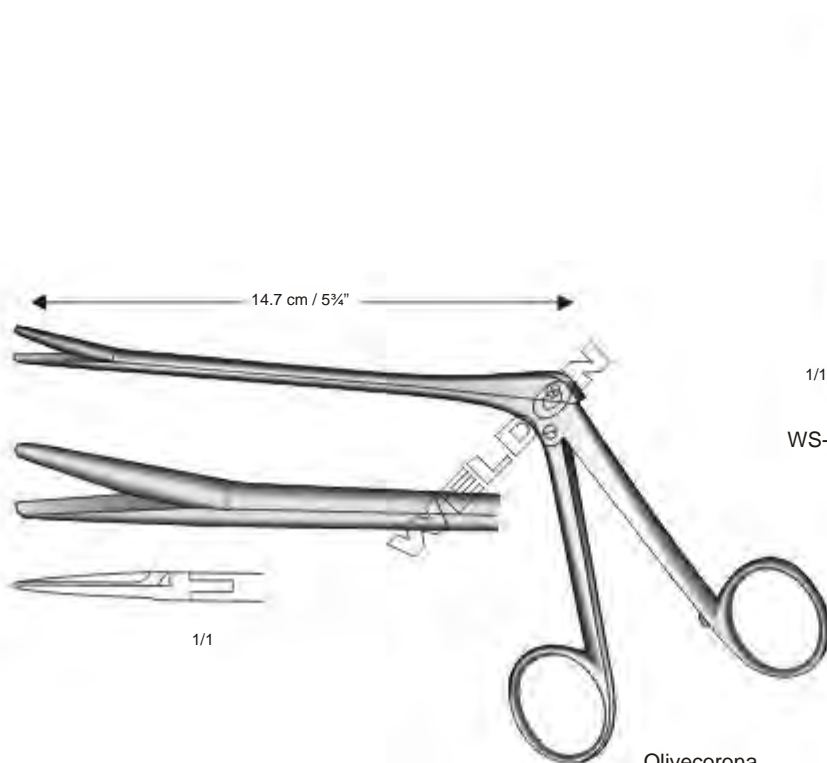

Heymann-Knight
WS-470-013
18 cm / 7"



Olivecorona
WS-470-014
22.5 cm / 9"

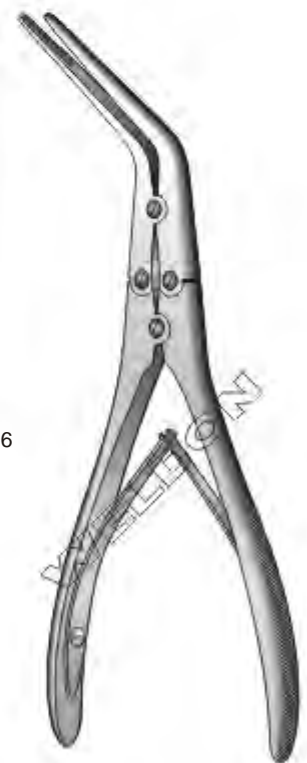
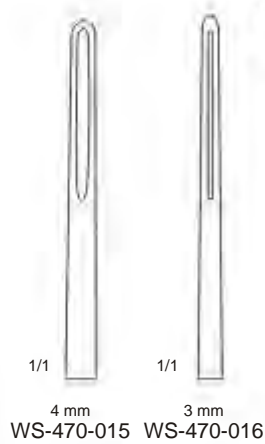

Kressner
22 cm / 8 3/4"



Quire
WS-471-017
12 cm / 4 3/4"

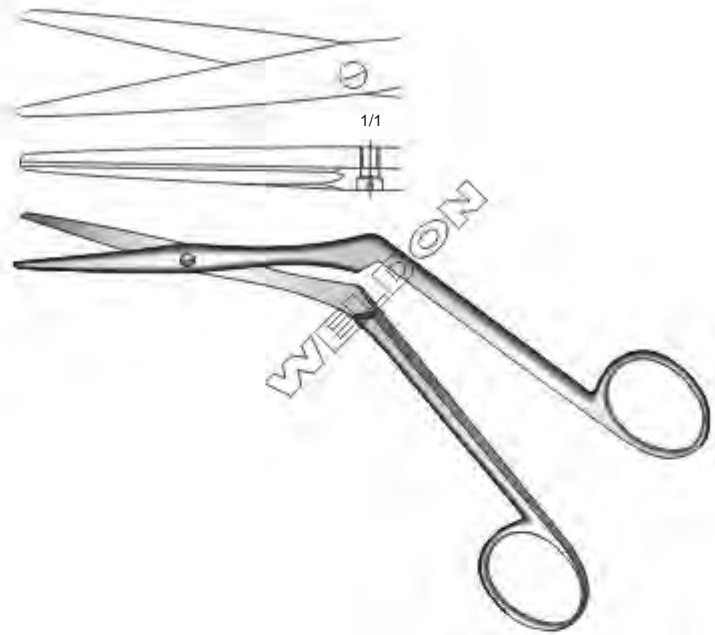

Heymann-Knight
WS-471-018
17.5 cm / 7"



Knight
WS-471-019
18 cm / 7"

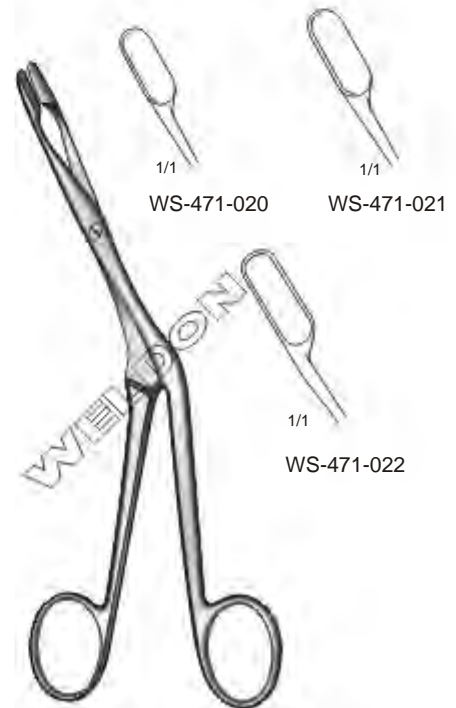

Heymann
18 cm / 7"

Nasal Septum and Cutting Forceps | Pinzas Para Tabique Y Cortantes Nasal
Septumzangen, Scharfe Nasenzangen



Graig
WS-472-023
16.5 cm / 6 1/2"



Craig-Domnick
16.5 cm / 6 1/2"



Luc
18.5 cm / 7 1/4"

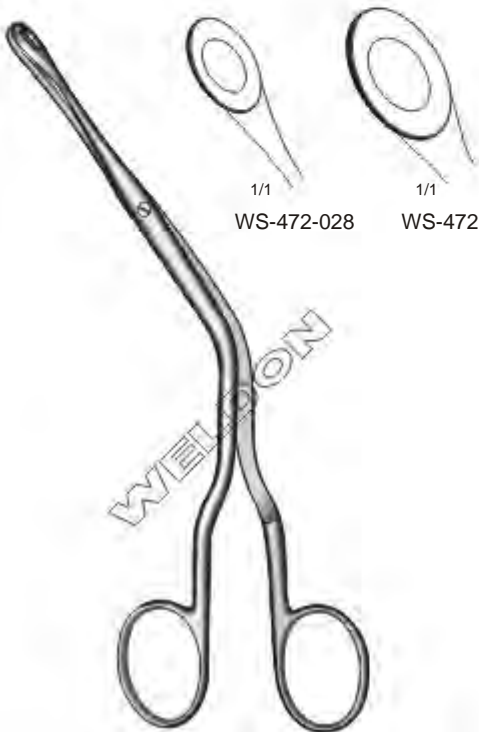

Luc
18.5 cm / 7 1/4"

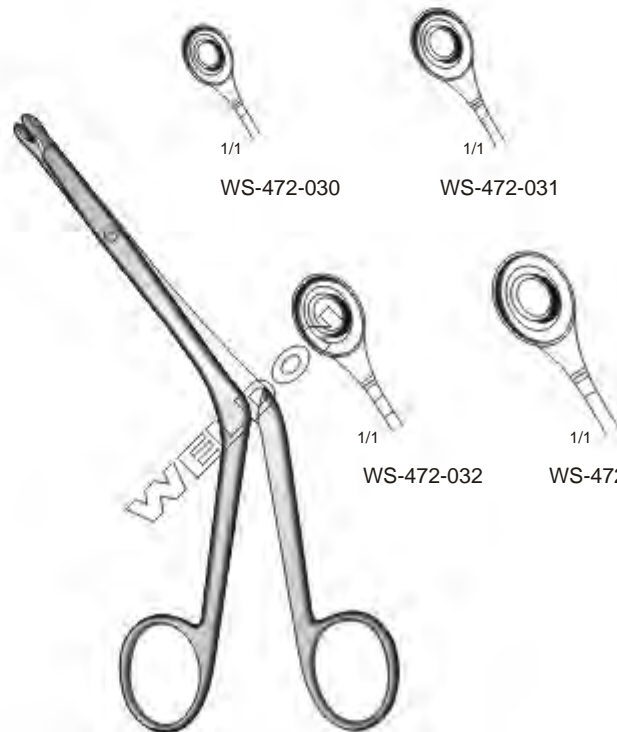

Brünings
16.5 cm / 6 1/2"

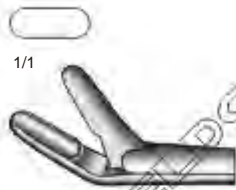

1/1

WS-473-036
Beak Upwards

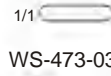

WS-473-034

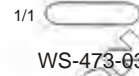

WS-473-035



Gruewald-Henke
Through Cutting



1/1

WS-473-037
Straight



Takahashi
19 cm / 7 1/2"

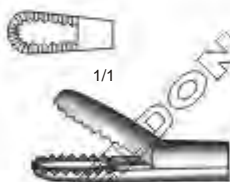

1/1

WS-473-038

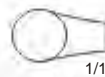

1/1



1/1

WS-473-039
Well With Neck

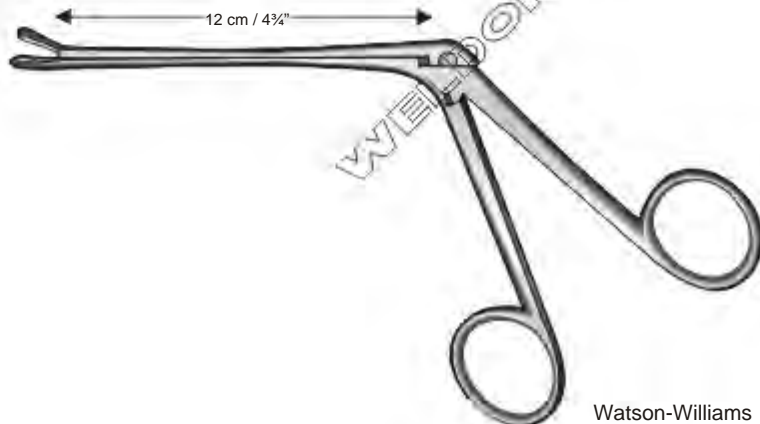

Watson-Williams
19 cm / 7 1/2"

Nasal Cutting Forceps | Pinzas Nasales Cortantes | Scharfe Nasenzangen



WS-474-040
5 mm



WS-474-041
7 mm



WS-474-042
9 mm



Watson-Williams
Ethmoidal Forceps

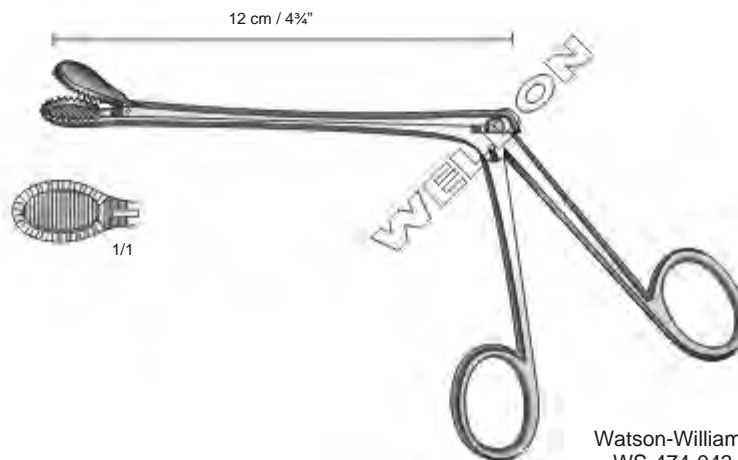

Watson-Williams
WS-474-043
Ethmoidal Forceps
Serrated Jaws

Nasal Cutting Forceps | Pinzas Nasales Cortantes | Scharfe Nasenzangen

 Straight	 1/1 WS-475-044 3 mm	 1/1 WS-475-045 3.5 mm	 1/1 WS-475-046 4 mm	 1/1 WS-475-047 4.5 mm	 1/1 WS-475-048 5 mm
 45° Angled At 45°	 1/1 WS-475-049 3 mm	 1/1 WS-475-050 3.5 mm	 1/1 WS-475-051 4 mm	 1/1 WS-475-052 4.5 mm	
 90° Angled At 90°	 1/1 WS-475-053 3 mm Fig. 1	 1/1 WS-475-054 3.5 mm Fig. 2	 1/1 WS-475-055 4.5 mm Fig. 3	 1/1 WS-475-056 5 mm Fig. 4	

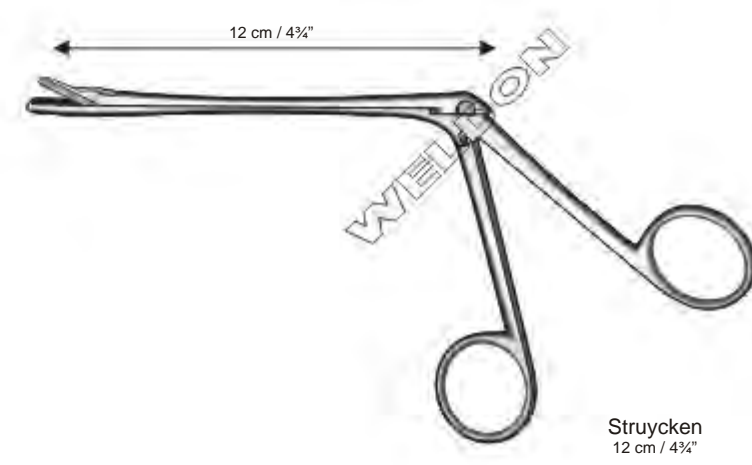
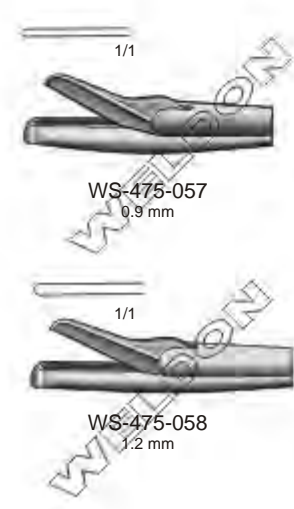
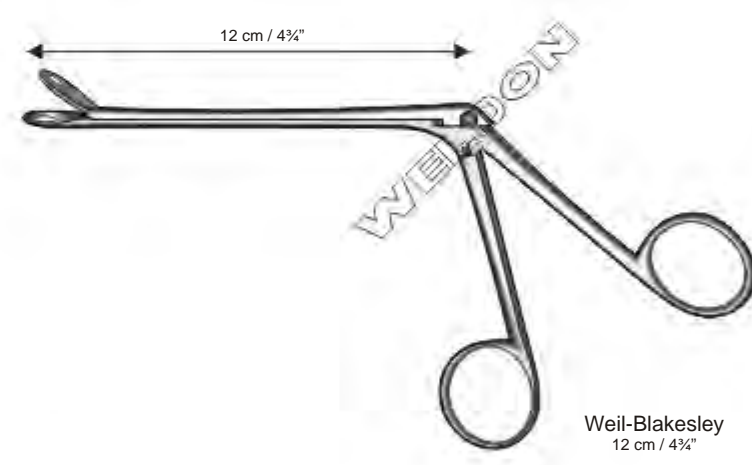

Nasal Cutting Forceps | Pinzas Nasaes Cortantes | Scharfe Nasenzangen

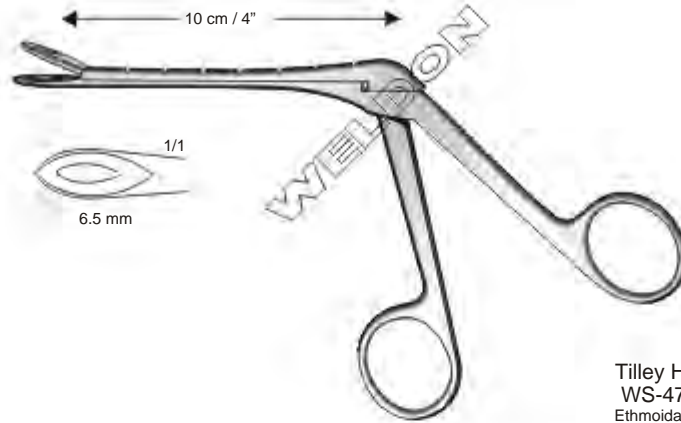

Tilley Henckel
WS-476-059
Ethmoidal Forceps
Graduated Shaft
Straight



WS-476-060
Ethmoidal Forceps
Straight

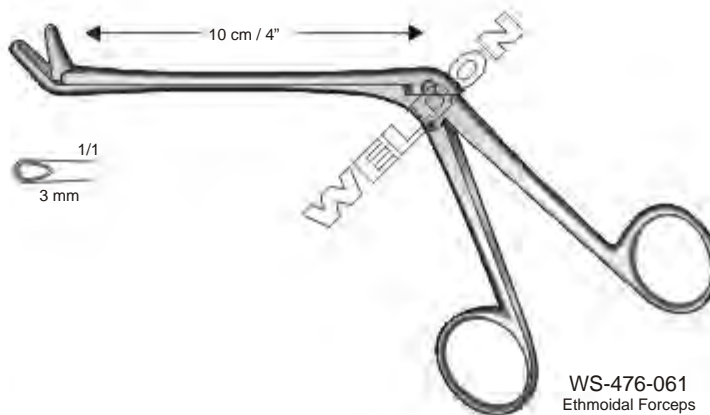

WS-476-061
Ethmoidal Forceps
Curved Upwards

Nasal Cutting Forceps | Pinzas Nasaes Cortantes | Scharfe Nasenzangen

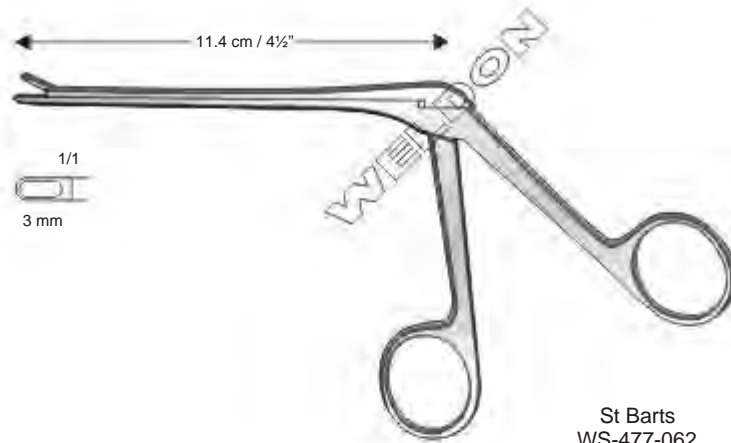

St Barts
WS-477-062
Rongeur, Straight

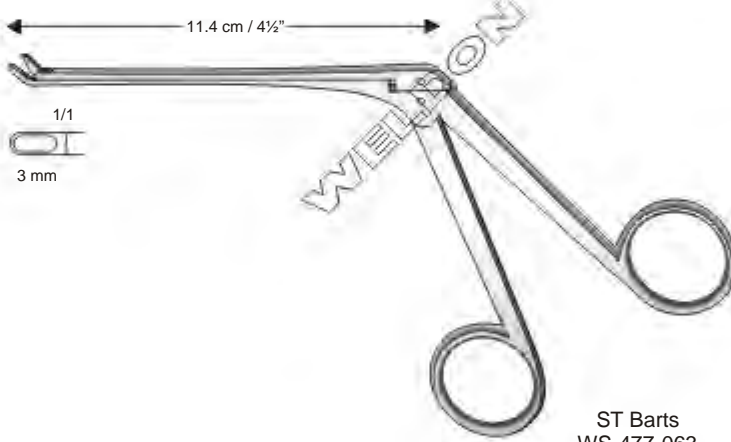
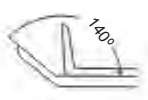

ST Barts
WS-477-063
Rongeur, Upward

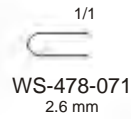
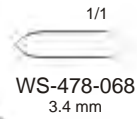
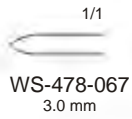
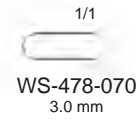
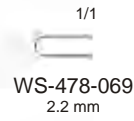
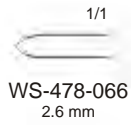
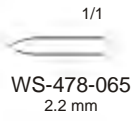

ST Barts
WS-477-064
Rongeur, Downward

Nasal Cutting Forceps | Pinzas Nasales Cortantes | Scharfe Nasenzangen

Myles
Shaft Length 12 cm / 4¾"



Myles
19 cm / 7½"
Shaft Length 12 cm / 4¾"



Hartmann
19 cm / 7½"
Shaft Length 12 cm / 4¾"



Hajek
WS-478-076
19 cm / 7½"
Shaft Length 12 cm / 4¾"



Schmeden
WS-478-077
19 cm / 7½"
Shaft Length 12 cm / 4¾"
Jaw Width 8 mm



Septum Straightening Forceps | Pinzas Para Enderezar el Tabique Nasal | Septumrichtzangen



Cottle-Walsham
23 cm / 9"



1/1
WS-479-078
Straight



1/1
WS-479-079
Left



1/1
WS-479-080
Right



Kerssner
WS-479-081
21 cm / 8 1/4"



Asch
WS-479-082
22.5 cm / 8 3/4"

Septum Forceps | Pinzas Para Tabique Nasal | Septumzangen



WS-480-083
Protecting Cap

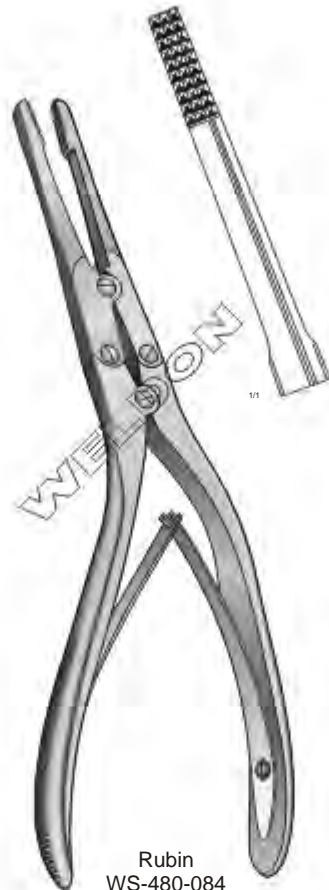

Rubin
WS-480-084
21 cm / 8 1/4"
Septum Motrselizer

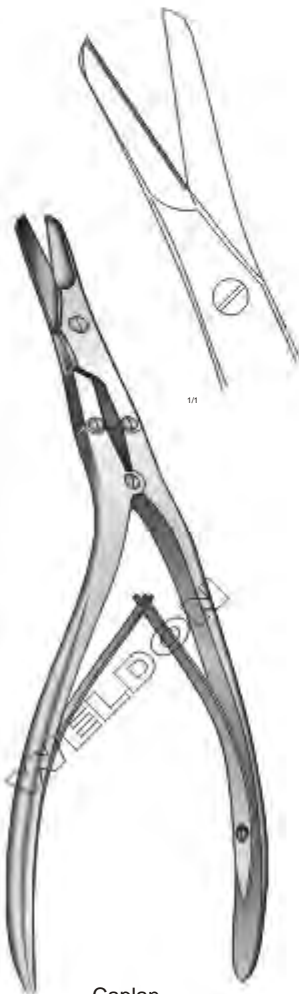

Caplan
WS-480-085
20 cm / 8"
Septum Scissors
Serrated



Killian
WS-480-086
21 cm / 8 1/2"
Septum Scissors
Serrated



Jansen-Struycken
WS-481-087
19 cm / 7½"



Middleton-Jansen
WS-481-088
19 cm / 7½"

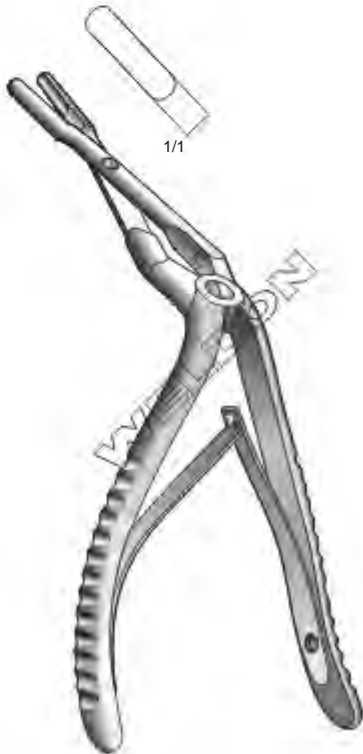

Middleton-Jansen
WS-481-089
19 cm / 7½"

Sphenoid Bone Punches | Pinzas Sacabocadas Para Esfenoides | Keilbeinstanzen

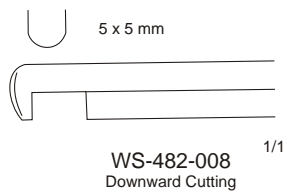
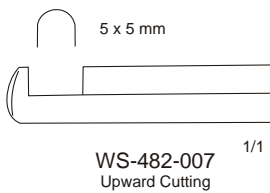
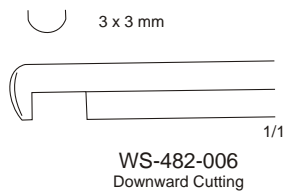
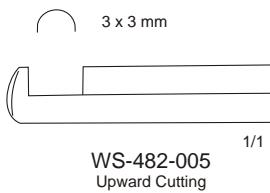
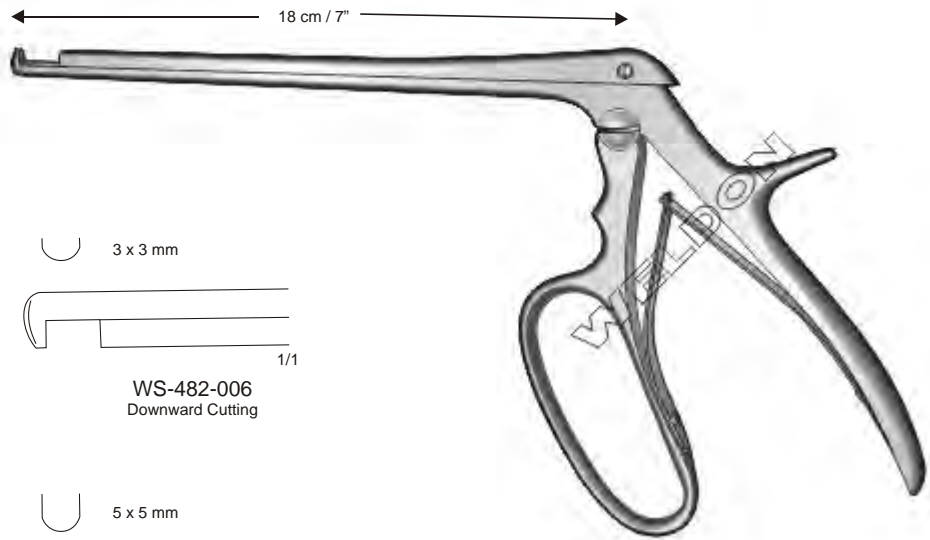
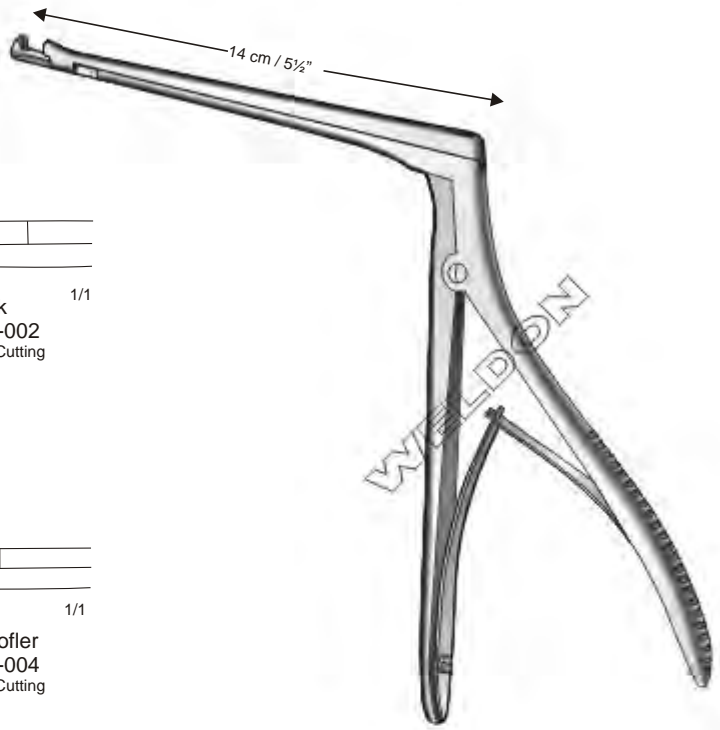
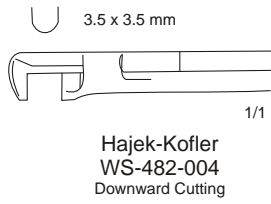
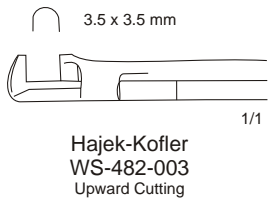
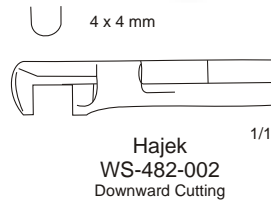
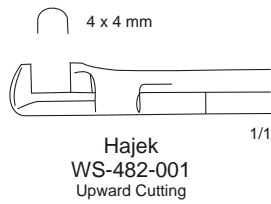

Ferris-Smith-Kerrison

Sphenoid Bone Punches | Pinzas Sacabocadas Para Esfenoides | Keilbeinstanzen

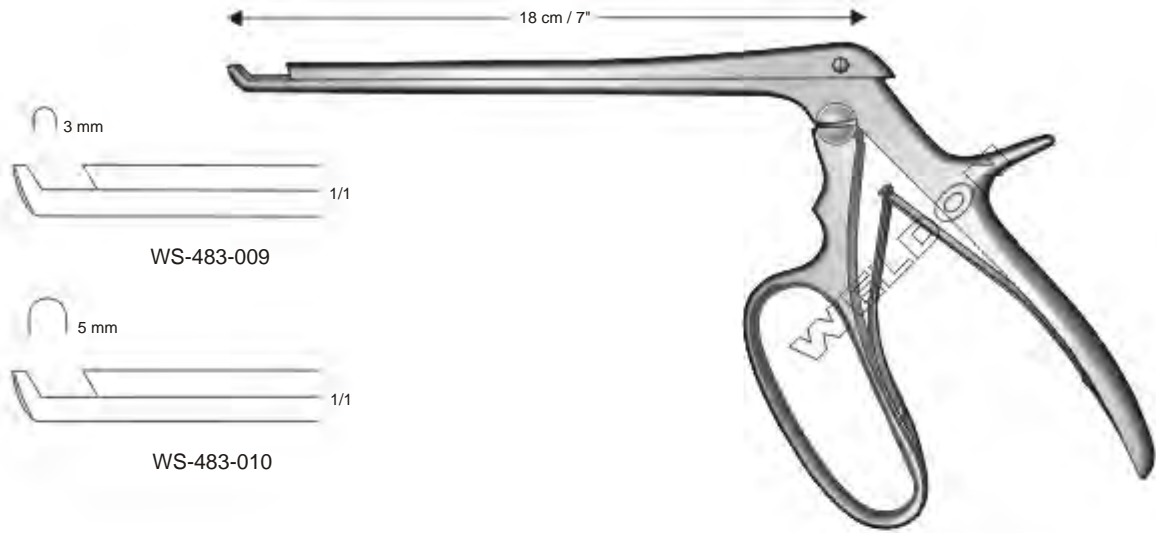

Ferris-Smith-Kerrison
18 cm / 7"
Obliquely Forward Cutting

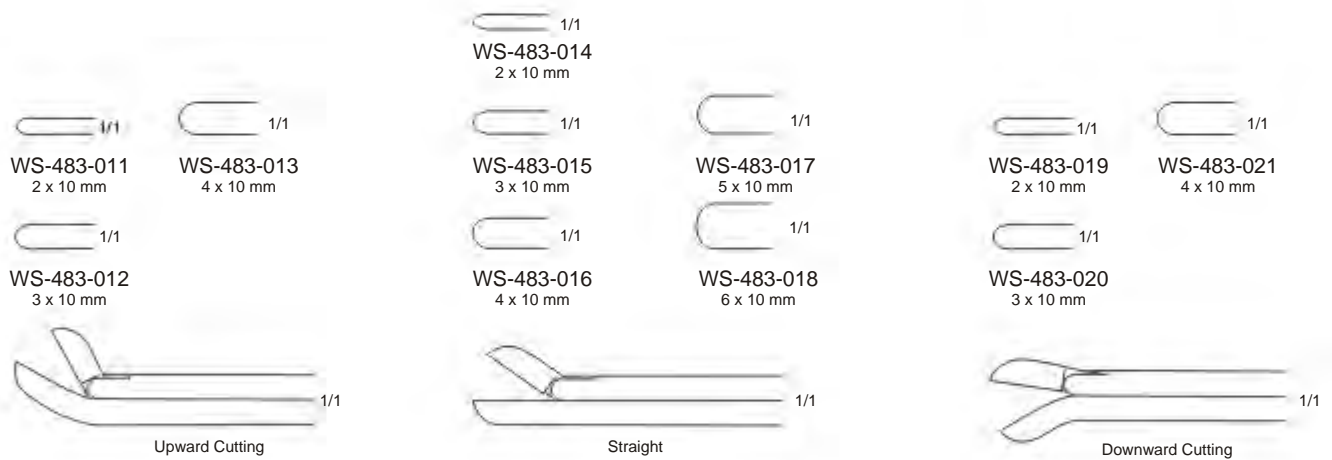

Ferris-Smith-Cushing

Sphenoid and Antrum Punch Forceps | Pinzas Sacabocadas Para Esfenoides y Seno Maxilar
Keilbeinstanzen, Antrumstanzen

3 x 3 mm
1/1
WS-484-023

4 x 4 mm
1/1
WS-484-024

5 x 5 mm
1/1
WS-484-025

6 x 6 mm
1/1
WS-484-026

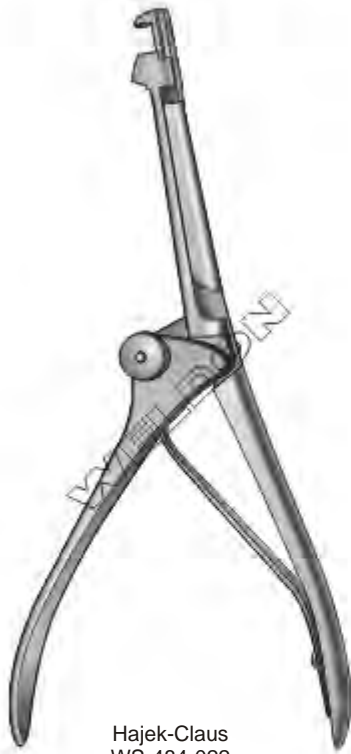

Hajek-Claus
WS-484-022
20 cm / 8"
5 mm Bite, Through Cutting



Kerrison
Upward Cutting

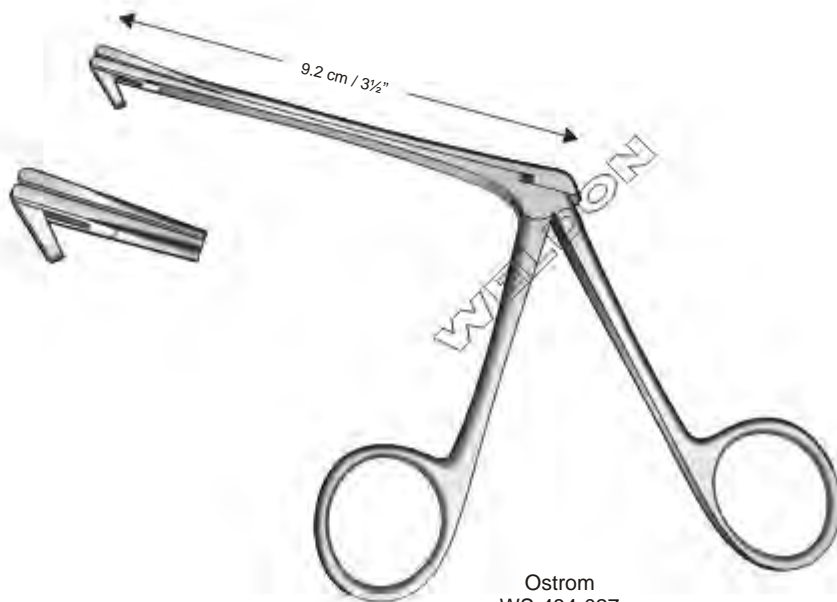

Ostrom
WS-484-027
Antrum Punch Reverse Action Jaw

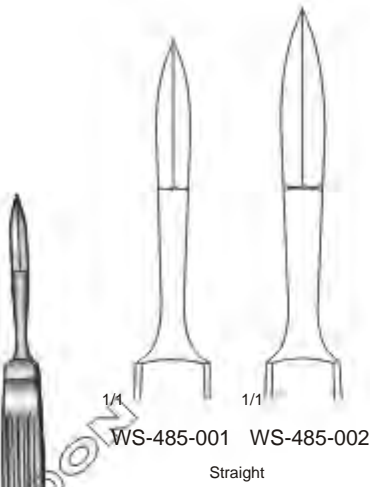

Joseph
15 cm / 6"
Double-Edged

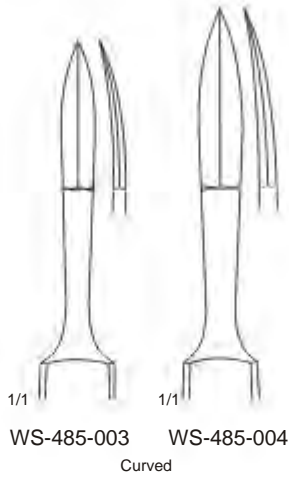

Fomon
WS-485-005
16 cm / 6¼"
Double-Edged

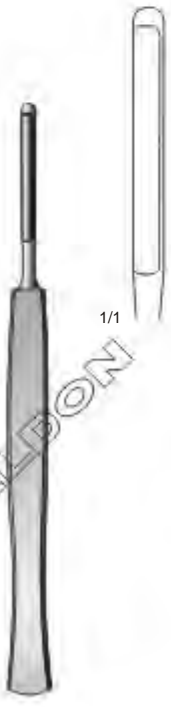

Joseph
WS-485-006
15 cm / 6"

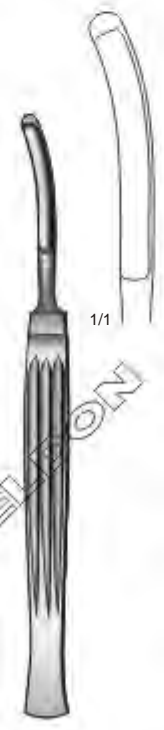

Converse
WS-485-007
16 cm / 6¼"

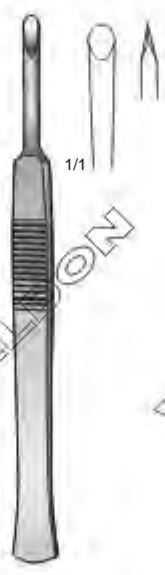

Cottle
WS-485-008
14 cm / 5½"



Cottle
WS-485-009
15 cm / 6"



Masing
WS-485-010
13 cm / 5½"
Curved Blade, Pointed

Septum Knives, Swivel Kinves | Cuchillos Para Tabique Nasal | Septummesser, Schwingmesser



Freer
WS-486-011
15 cm / 6"



Freer
WS-486-012
19 cm / 7½"



Freer
WS-486-013
19 cm / 7½"



Freer
WS-486-014
19 cm / 7½"



Ballenger
21 cm / 8¼"



1/1

WS-486-015
3 mm



1/1

WS-486-016
4 mm



1/1

WS-486-017
5 mm



Ballenger
20 cm / 8"



1/1

WS-486-018
3 mm



1/1

WS-486-019
4 mm



1/1

WS-486-020
5 mm

Septum Elevators | Elevadores Para Tabique Nasal | Septumelevatorien



Mckenty
WS-487-021
20.5 cm / 8"

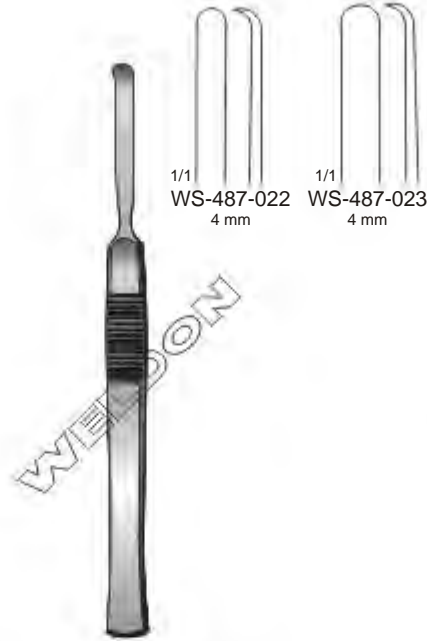

Mckenty
15.5 cm / 6"

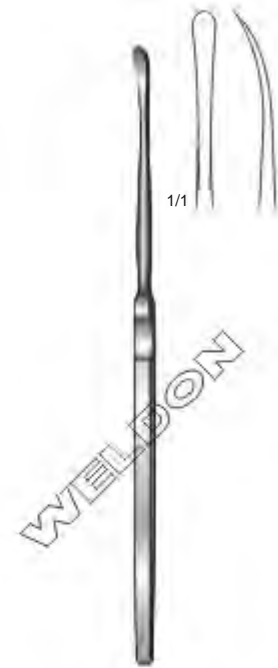

Halle
WS-487-024
16 cm / 6 1/4"



Freer
WS-487-025
19 cm / 7 1/2"
Sharp



Freer
WS-487-026
19 cm / 7 1/2"
Blunt



Freer
WS-487-027
18.5 cm / 7 1/4"
Sharp / Blunt

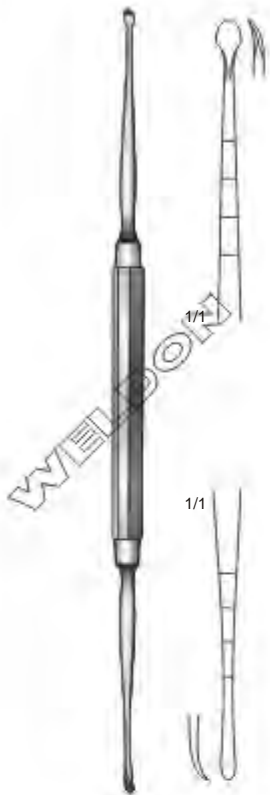

Freer
WS-487-028
20.5 cm / 8"
Sharp / Blunt

Septum Elevators | Elevadores Para Tabique Nasal | Septumelevatorien

Masing
WS-488-029
 21 cm / 8 1/4"
 3 / 2 mm



Cottle
WS-488-030
 21 cm / 8 1/4"



Killian
WS-488-031
 18 cm / 7"
 4 / 4 mm



Killian
WS-488-032
 23 cm / 9"
 4.5 / 4.5 mm



1/1



Pierce
WS-488-033
 21 cm / 8 1/4"



1/1



Pennington
WS-488-034
 21 cm / 8 1/4"
 4 / 4 mm



1/1



Roger
WS-488-035
 19.5 cm / 7 3/4"
 4 / 4 mm

Septum Elevators | Elevadores Para Tabique Nasal | Septumelevatorien



Hill
WS-489-036
22 cm / 8 3/4"
Semi-Sharp / Blunt
Elevator

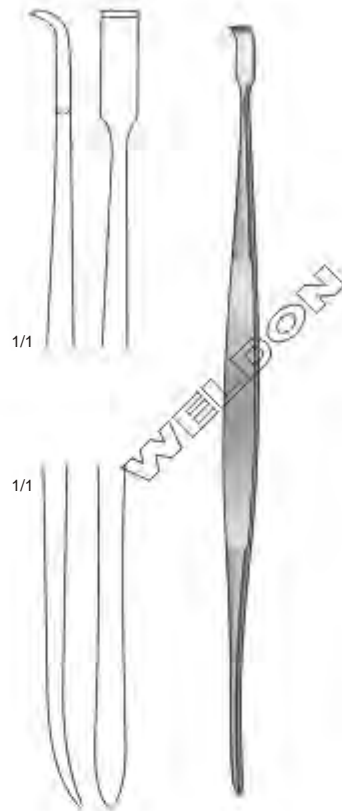

Howarth
WS-489-037
21.5 cm / 8 1/2"
Elevator



Watson-Cheyen
WS-489-038
13 cm, 5 1/8"
Raspatory



Watson-Cheyen
WS-489-039
19 cm / 7 1/2"
Raspatory

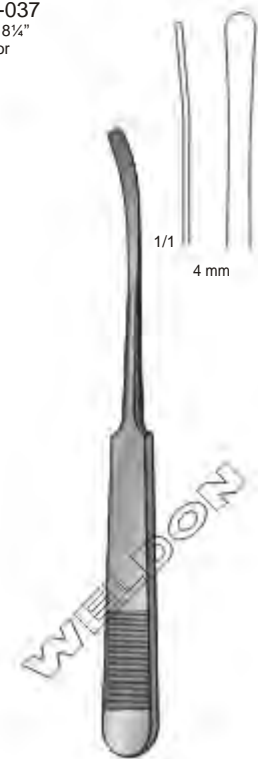

St Clair Thompson
WS-489-040 Sharp
WS-489-041 Blunt
16 cm / 6 1/4"
Raspatory, Periosteal Elevator

Septum Elevators | Elevadores Para Tabique Nasal | Septumelevatorien

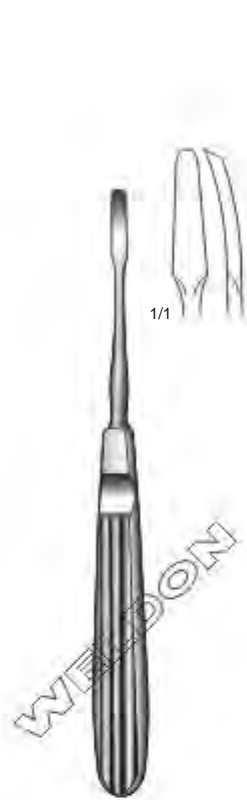

Joseph
WS-490-042
16 cm / 6 1/4"

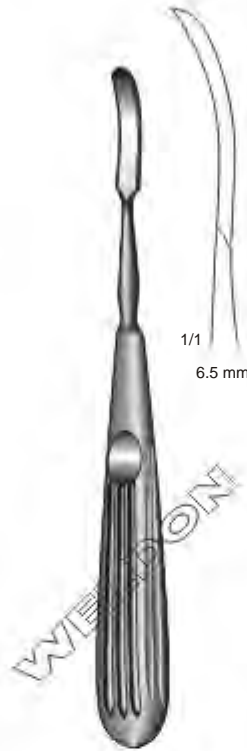

Joseph
WS-490-043
18 cm / 7"

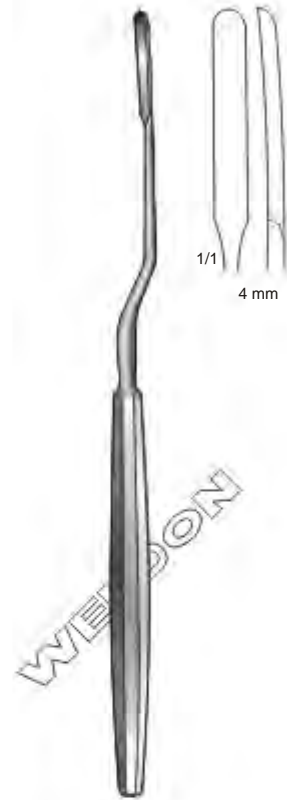

Joseph-Masing
WS-490-044
22 cm / 8 3/4"



Cottle
WS-490-045
21 cm / 8 1/4"
4.5 / 4.5 mm



Cottle
WS-490-046
20 cm / 8"

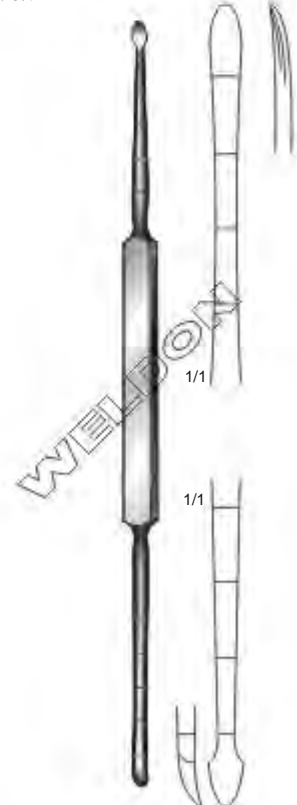

Cottle
WS-490-047
21 cm / 8 1/4"
3.3 / 3.7 mm



Freer
19 cm / 7½"



Freer
16 cm / 6¼"
Curved



Freer
16 cm / 6¼"
Straight



Freer
15 cm / 6"
Septum Gouge



Freer
15 cm / 6"
Septum Gouge



Ballenger
15.5 cm / 6"

- WS-491-053
2 mm
- WS-491-054
4 mm
- WS-491-055
6 mm
- WS-491-056
8 mm



Killian
WS-491-057
17 cm / 6¾"



Killian-Claus
WS-491-058
17 cm / 6¾"



Gorney
WS-491-059
18 cm
Suction Respiratory



Fomon
17 cm / 6¾"



WS-492-060
4 mm



WS-492-061
5 mm



WS-492-062
6 mm



WS-492-063
7 mm

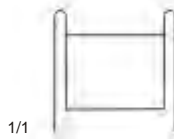

WS-492-064
16 mm

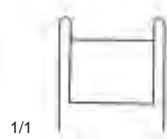

WS-492-065
14 mm

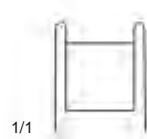

WS-492-066
12 mm

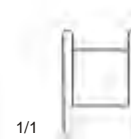

WS-492-067
10 mm



Cinelli
16 cm / 6¼"

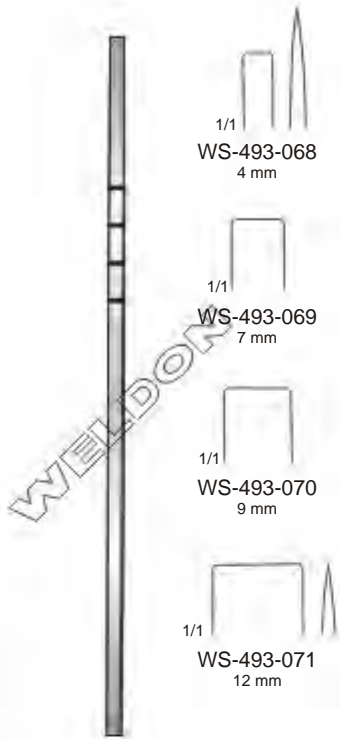

Cottle
18 cm / 7"



Cottle
WS-493-072
18 cm / 7"

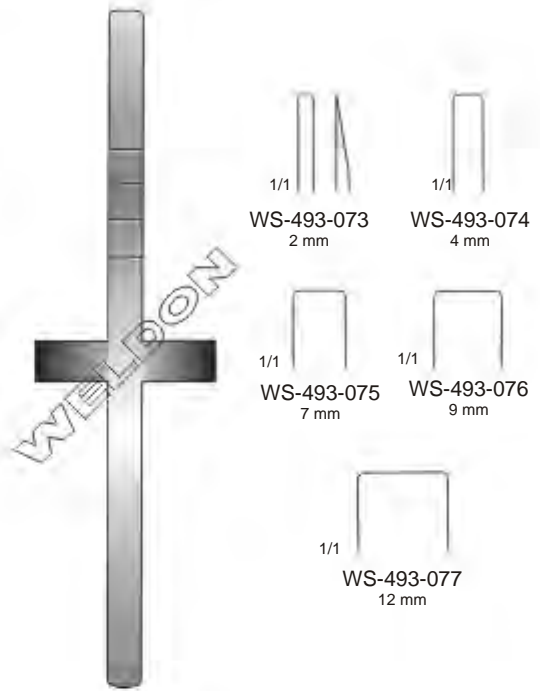

Cottle
18 cm / 7"

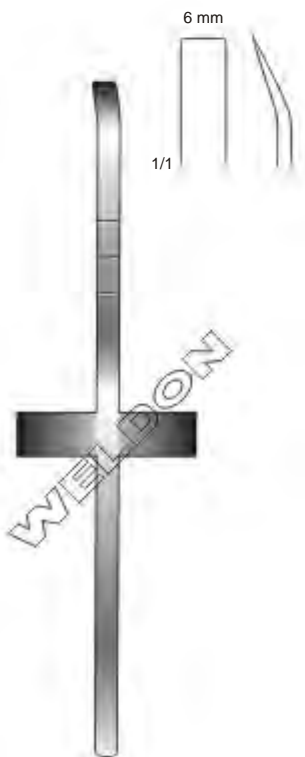

Cottle
WS-493-078
18 cm / 7"

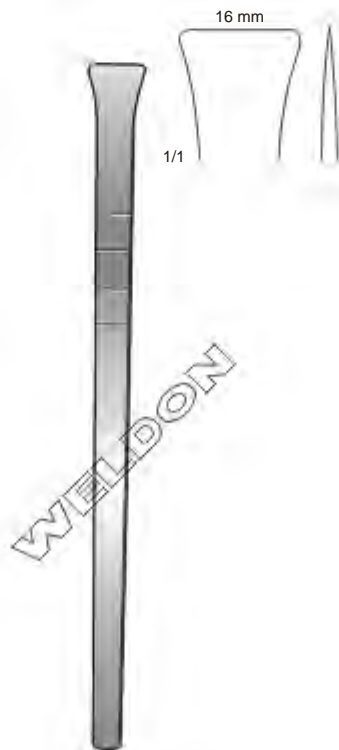

Cottle
WS-493-079
18 cm / 7"

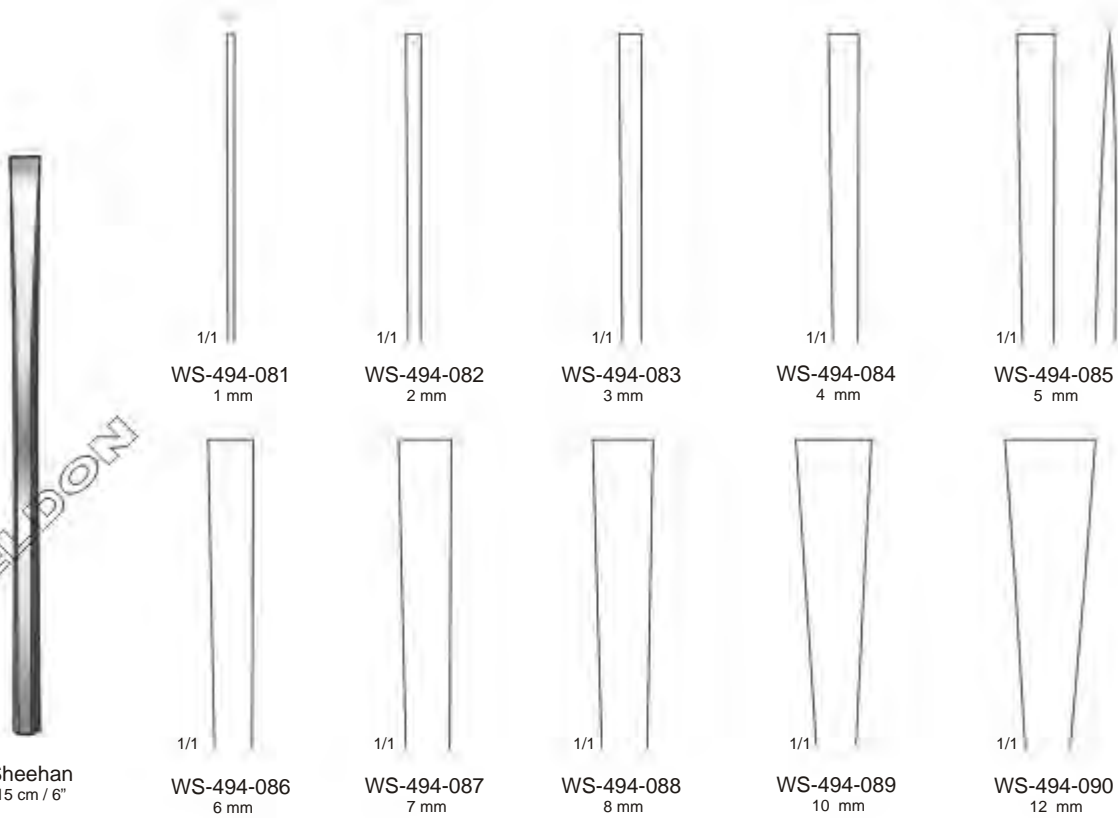
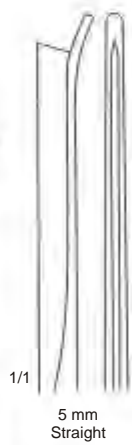

Cottle
WS-493-080
18 cm / 7"

Osteotomes | Osteótomos | Osteotome

Sheehan
15 cm / 6"

Silver
WS-494-091
18 cm / 7"

Silver
WS-494-092
18 cm / 7"

Silver
WS-494-093
18 cm / 7"



Joseph
WS-495-094
15 cm / 6"
Mucosa Hooklet
Sharp



Cottle
WS-495-095
17 cm / 6 3/4"
Sharp



Cottle
15 cm / 6"
Sharp



WS-495-096 WS-495-097 WS-495-098



Lange
WS-495-099
22 cm / 8 3/4"
Button End, Alar Hooklet



Fomon
WS-495-100
17 cm / 6 3/4"
Button End, Alar Hooklet



Killian
WS-495-101
16 cm / 6 1/4"
Probe, Angled



Killian
WS-495-102
16.5 cm / 6 1/2"
Probe, Curved

Nasal Hooks | Ganchitos Nasaes | Nasenhäkchen



Freer
WS-496-103
15 cm / 6"
Sharp



1/1
WS-496-104
2 mm

1/1
WS-496-105
5 mm

1/1
WS-496-106
7 mm

1/1
WS-496-107
10 mm

Joseph
16 cm / 6 1/4"



Fomon
WS-496-108
16 cm / 6 1/4"
Button Ended



Cottle-Neivert
WS-496-109
20 cm / 8"

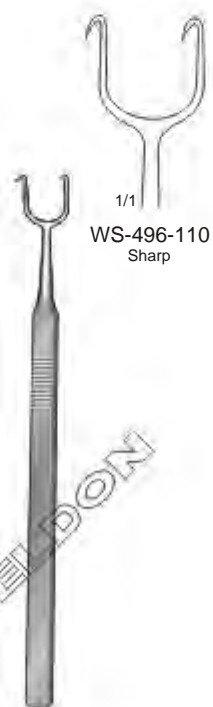

1/1
WS-496-110
Sharp

1/1
WS-496-111
Blunt / Sharp

1/1
WS-496-112
Sharp / Blunt

Cottle
15 cm / 6"



Cottle
WS-496-113
14 cm / 5 1/2"



Cottle
WS-497-114
15 cm / 6"



Aufricht
WS-497-115
13.5 cm / 5 1/4"
Blunt



Kilner
WS-497-116
10 cm / 4"
Sharp

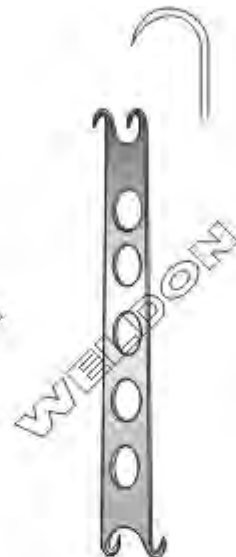

Converse
WS-497-117
12 cm / 4 3/4"
Alar Hooklet, Sharp



Aufricht
WS-497-118
19 cm / 7 1/2"



Yankauer
16 cm / 6 1/4"
Septum Suture Needles



WS-497-119



WS-497-120



WS-497-121



WS-497-122



WS-497-123



WS-497-124



WS-497-125



WS-497-126



WS-497-127



Neivert
WS-497-128
17 cm / 6 3/4"



Cottle
WS-497-129
14 cm / 5 1/2"
Saddle Hook

Sharp Currettes | Curetas Cortantes | Scharfe Küretten



Coakley
17 cm / 6¾"



WS-498-130



WS-498-131



WS-498-132



WS-498-133



WS-498-134



WS-498-135



Pratt
WS-498-136
21 cm / 8¼"



Faulkner
WS-498-137
21 cm / 8¼"



WS-498-138
20 cm / 8"

Antrum Curettes, Cheek Retractors | Curetas Para El Antro, Separadores Para Mejillas
Antrum Küretten, Wangenhalter



Sewall
WS-499-139
20 cm / 8"
Antrum Elevator



Mackie
WS-499-140
19.7 cm 7 3/4"
Antrum Curette

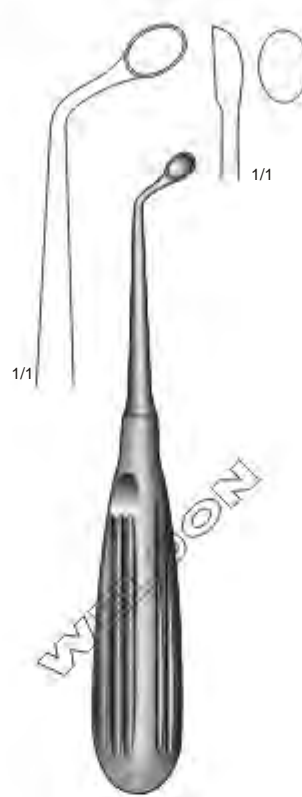

Uffenorde
WS-499-141
17 cm / 6 1/4"
Antrum Curette, Right

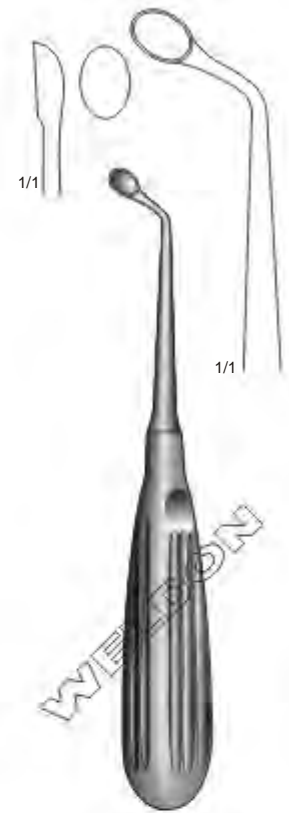

Uffenorde
WS-499-142
17 cm / 6 1/4"
Antrum Curette, Left



Passow
12 cm / 4 3/4"
Haemostatic Chisels



Sternberg
WS-499-145 12 cm / 4 3/4"
WS-499-146 13 cm / 5"
WS-499-147 13.5 cm / 5 1/2"
Cheek Retractor

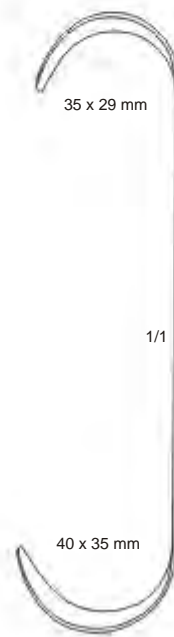

WS-499-148



WS-499-149

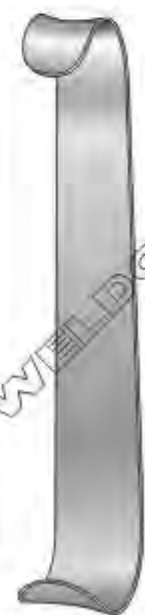

Kilner
15 cm / 6"
Cheek Retractor

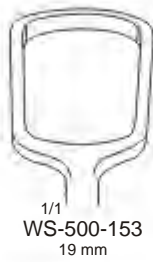
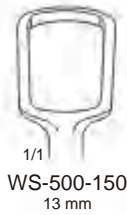
Adenoid Currettes | Cuchillos Para Adenoides | Ringmesser

Beckmann
22 cm / 8¾"
Straight Shaft



Beckmann
22 cm / 8¾"
Angled Shaft



1/1
WS-501-162



1/1
WS-501-167
8.5 mm



1/1
WS-501-163



1/1
WS-501-164

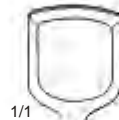

1/1
WS-501-168
10 mm



1/1
WS-501-169
13 mm



1/1
WS-501-165



1/1
WS-501-166



1/1
WS-501-170
16.5 mm



1/1
WS-501-171
18 mm



Beckmann
22.5 cm / 8¾"
Trapezoidal Fenestrated



St. Clair Thomson
21 cm / 8¼"
With Cage

Adenotomes, Antrum Retractor | Adenotomos, Separador De Antrum
Pharynx Tonsillotom, Retraktor Antrum

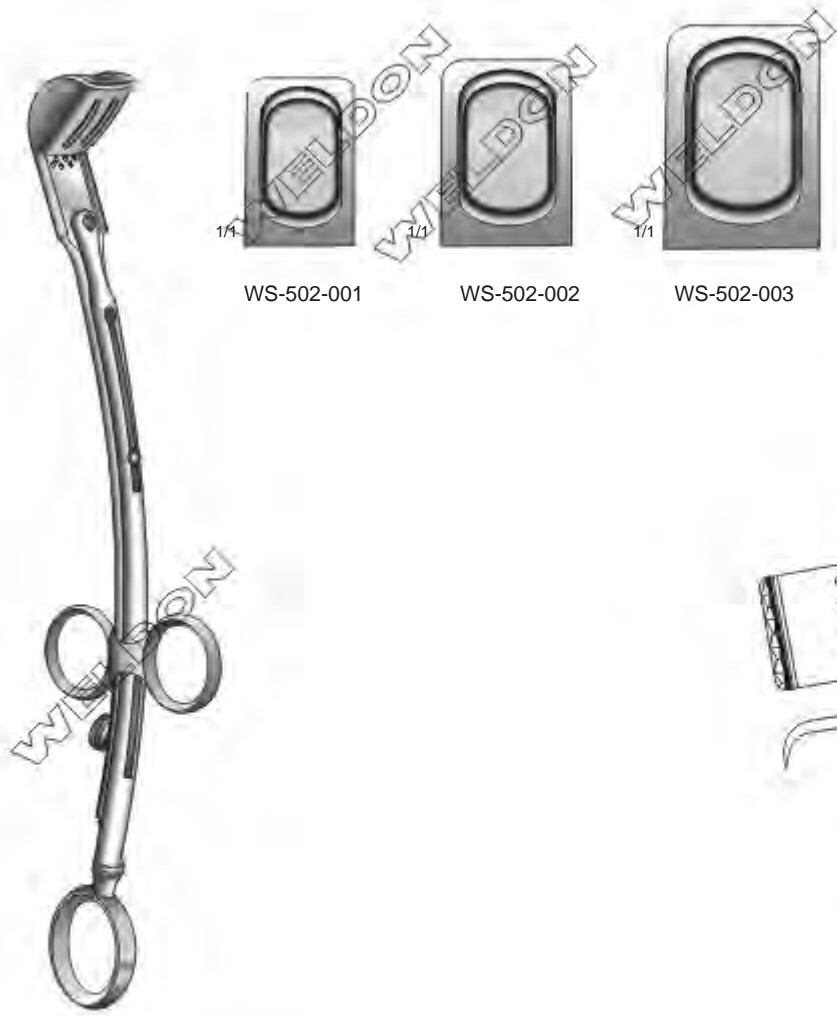

WS-502-001

WS-502-002

WS-502-003



La Force
25 cm / 10"
Adenotomes
With One Spare Blade

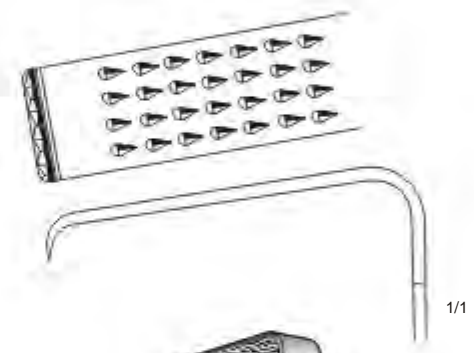

Bruenings Brunk
WS-502-004
21.5 cm / 8½"
Antrum Retractor



Joseph
WS-503-005
17 cm / 6¾"
Left



Joseph
WS-503-006
17 cm / 6¾"
Right



WS-503-007
Straight



WS-503-008
Left



WS-503-009
Right



Joseph
19 cm / 7½"
Working Length 40 mm

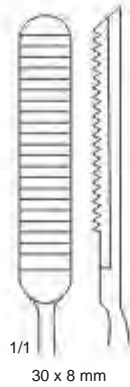

Cottle
WS-504-010
21 cm / 8 1/4"



Aufricht
21 cm / 8 1/4"

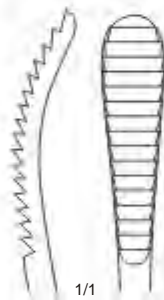

WS-504-011
Pushing Cut
32 x 9 mm

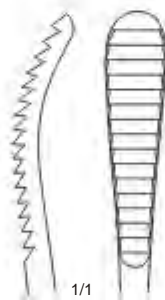

WS-504-012
Drawing Cut
32 x 9 mm



Lewis
19 cm / 7 1/2"
Drawing Cut 15 x 8 mm



WS-504-013
Fine

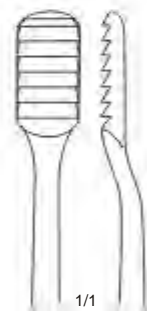

WS-504-014
Coarse



Maltz
19.5 cm / 7¾"
With Tungsten Carbide Insert



1/1



1/1 1

WS-505-015



1/1 2

WS-505-016



1/1 3

WS-505-017

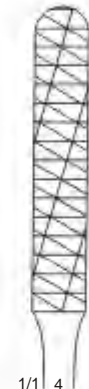

1/1 4

WS-505-018

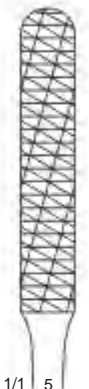

1/1 5

WS-505-019



1/1 6

WS-505-020



1/1 7

WS-505-021



1/1 8

WS-505-022



1/1 9

WS-505-023



1/1 10

WS-505-024



Gallaher
WS-506-025
17 cm / 6 3/4"
45 x 6 mm

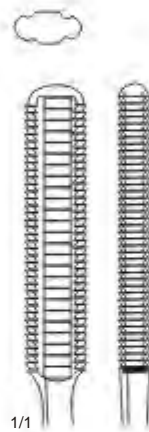

1/1

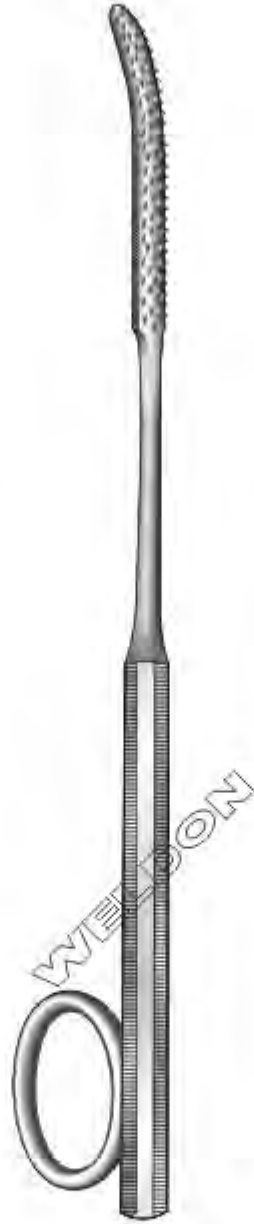

Gallaher
WS-506-026
17 cm / 6 3/4"
45 x 6 mm

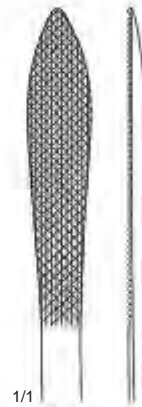

1/1



Gallaher
WS-506-027
17 cm / 6 3/4"
45 x 6 mm



Maltz
WS-506-028
17 cm / 6 3/4"
34 x 7 mm



Josph
WS-506-029
16 cm / 6 1/4"
45 x 9 mm



Obwegeser
WS-507-030 Fine
WS-507-031 Medium Fine
19 cm / 7½"
Flat



Obwegeser
WS-507-032 Fine
WS-507-033 Medium Fine
19 cm / 7½"
Convex



Obwegeser
WS-507-034 Fine
WS-507-035 Medium Fine
19 cm / 7½"
Roof Shaped

Nasal Rasps | Escofinas Nasales | Nasenraspeln



Fomon
20 cm / 8"
With Tungsten Carbide

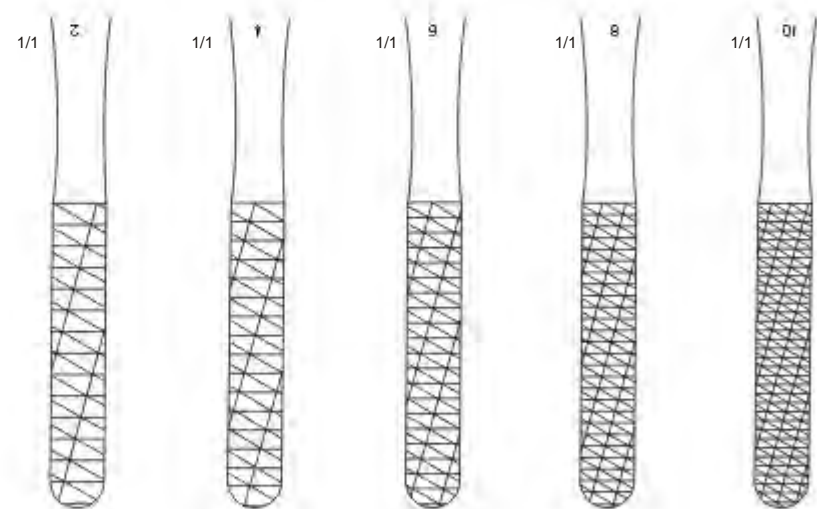
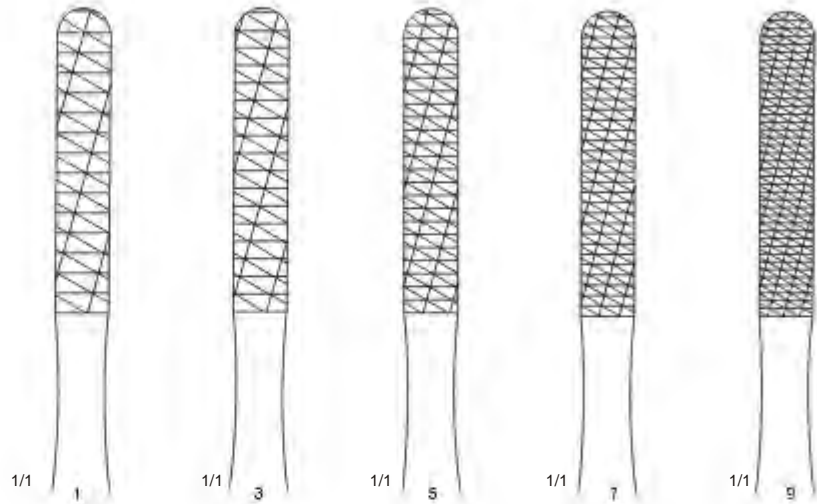

WS-508-036
30 x 8 mm

WS-508-037
40 x 7 mm

WS-508-038
40 x 7 mm

WS-508-039
40 x 7 mm

WS-508-040
40 x 7 mm