



www.weldoninstruments.com

PROVEEDOR EXCLUSIVO:



Bulldog Clamps

Rib Shears

Rib Spreaders

Cardiovascular Forceps

341 - 384

Cardiovascular

Cardiovascular
Cardiovascular
GefaBchirurgie

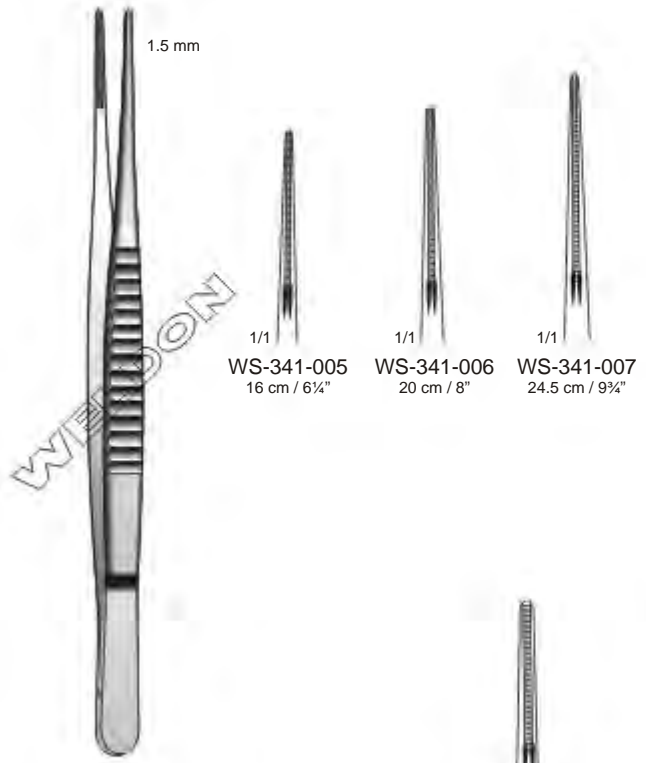
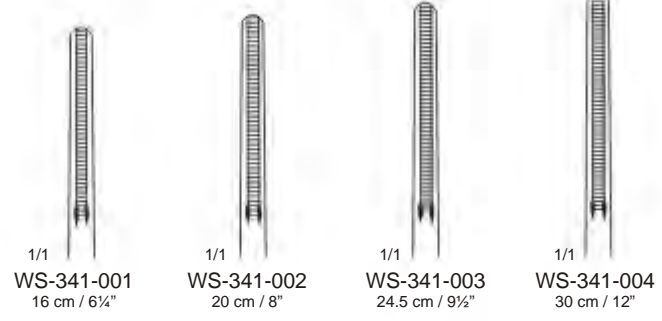

Vascular Forceps | Pinzas de Disección Vascolar | Gefäßpinzetten

2 mm



DeBakey



1/1
WS-342-012
16 cm / 6 1/4"



1/1
WS-342-013
20 cm / 8"



1/1
WS-342-014
24 cm / 9 1/2"



1/1
WS-342-015
30 cm / 12"

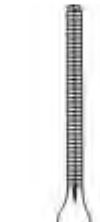

1/1
WS-342-016
16 cm / 6 1/2"

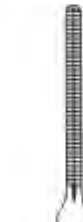

1/1
WS-342-017
20 cm / 8"



Cooley

3.5 mm



DeBakey



1/1
WS-342-018
16 cm / 6 1/4"



1/1
WS-342-019
20 cm / 8"



1/1
WS-342-020
24 cm / 9 1/2"



1/1
WS-342-021
30 cm / 12"



Diethrich
 WS-343-022A 20 cm / 8"
 WS-343-022B 24 cm / 9½"
 WS-343-022C 30 cm / 12"
 1.0 mm Tip



Diethrich
 WS-343-022D 14 cm / 5½"
 WS-343-022E 16 cm / 6¼"
 WS-343-022F 18 cm / 7"
 WS-343-022G 20 cm / 8"
 WS-343-022H 24 cm / 9½"
 WS-343-022K 30 cm / 12"
 1.3 mm Tip

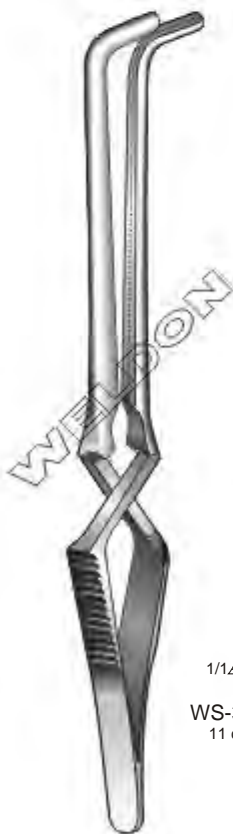

WS-343-022 11 cm / 4 7/8"
 WS-343-023 12 cm / 4 3/4"

Gregory

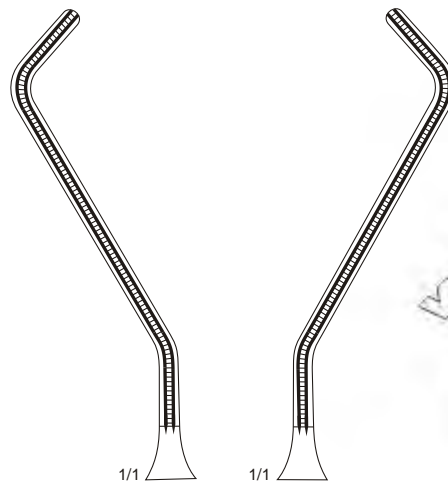

WS-343-024 WS-343-025



Gregory
 11 cm / 4 7/8"

Bulldog Clamps | Clamps Bulldog | Bulldogklemmen

1/1

DeBakey
 WS-344-026 7.5 cm / 3"
 WS-344-027 8.5 cm / 3 $\frac{3}{8}$ "
 WS-344-028 10.5 cm / 4 $\frac{1}{8}$ "
 WS-344-029 12 cm / 4 $\frac{3}{4}$ "



1/1

DeBakey
 WS-344-030 7 cm / 2 $\frac{3}{4}$ "
 WS-344-031 8 cm / 3 $\frac{1}{8}$ "
 WS-344-032 10 cm / 4"
 WS-344-033 11.5 cm / 4 $\frac{1}{2}$ "



Glover
 WS-344-034 7 cm / 2 $\frac{3}{4}$ "
 WS-344-035 8 cm / 3 $\frac{1}{8}$ "
 WS-344-036 9 cm / 3 $\frac{1}{2}$ "
 WS-344-037 11 cm / 4 $\frac{3}{8}$ "

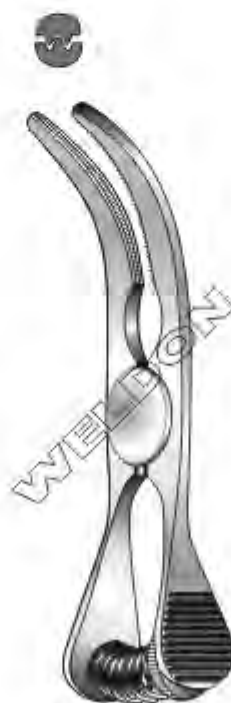

Glover
 WS-344-038 6.5 cm / 2 $\frac{1}{2}$ "
 WS-344-039 7.5 cm / 3"
 WS-344-040 8.5 cm / 3 $\frac{3}{8}$ "
 WS-344-041 10.5 cm / 4 $\frac{1}{8}$ "



Glover
 WS-344-042
 5 cm / 2"

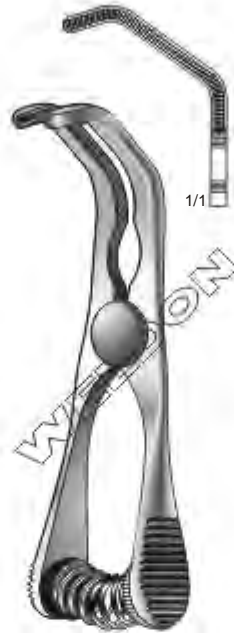

DeBakey
WS-345-043
6 cm / 2 $\frac{3}{8}$ "

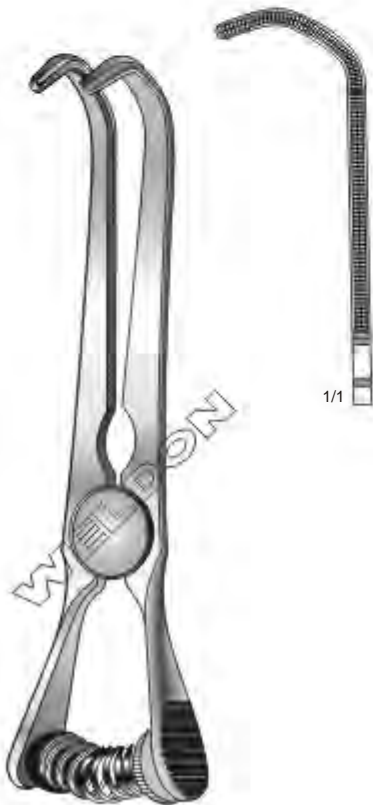

DeBakey
WS-345-044
11.5 cm / 4 $\frac{1}{2}$ "

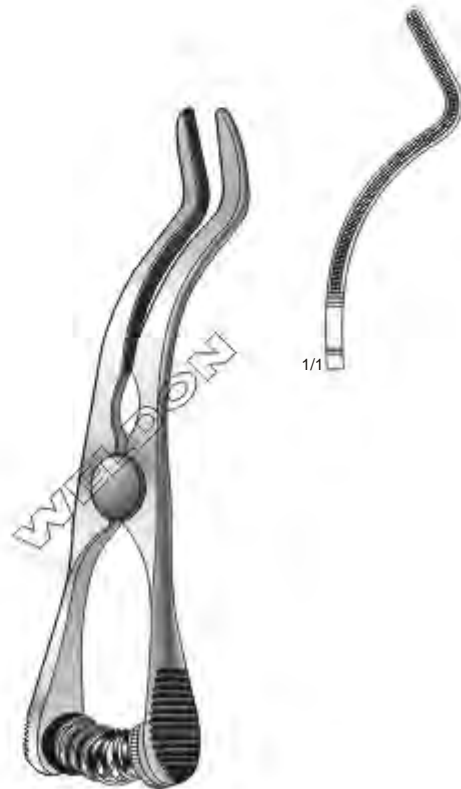

DeBakey
WS-345-045
8 cm / 3 $\frac{1}{8}$ "

Cardiovascular Forceps | Pinzas Cardiovasculares | Gefäßklemmen



DeBakey-Mosquito
12.5 cm / 5"



WS-346-001
Straight



WS-346-002
Curved



DeBakey-Mosquito
15 cm / 6"



WS-346-003
Straight



WS-346-004
Curved



DeBakey-Rankin
16 cm / 6 1/4"
Haemostatic Forceps



WS-346-005



WS-346-006



WS-347-007
14 cm / 5½"

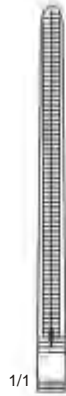

WS-347-008
16 cm / 6¼"

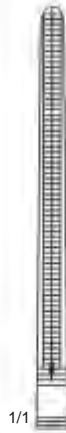

WS-347-009
18 cm / 7"

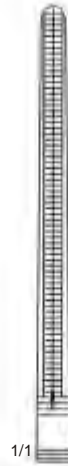

WS-347-010
20 cm / 8"



DeBakey-Pean
Straight
Haemostatic Forceps



WS-347-011
14 cm / 5½"



WS-347-012
16 cm / 6¼"



WS-347-013
18 cm / 7"



WS-347-014
20 cm / 8"



DeBakey-Pean
Curved
Haemostatic Forceps

Cardiovascular Forceps | Pinzas Cardiovasculares | Gefäßklemmen

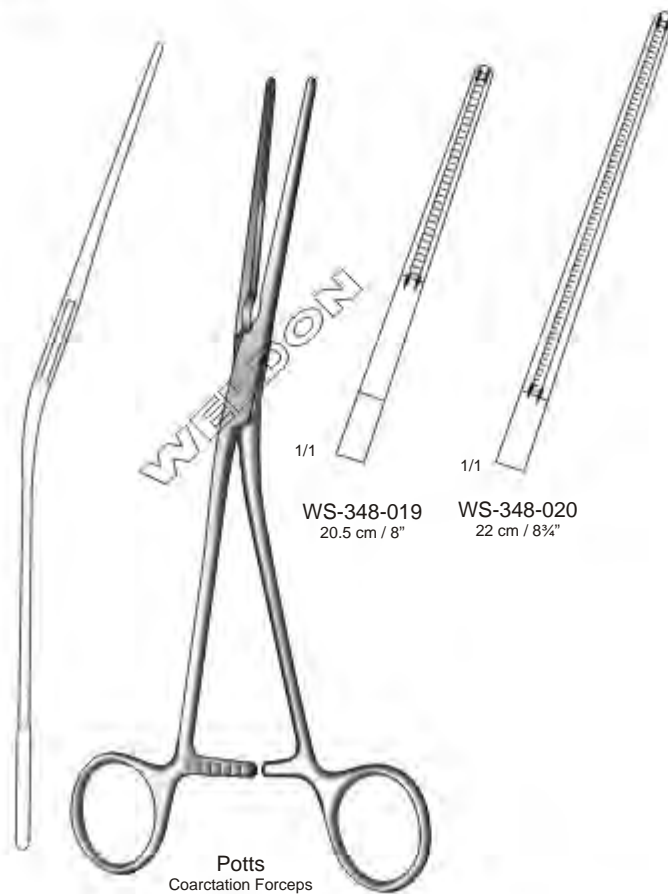



WS-349-021
22 cm / 8 3/4"
Anastomosis Clamps

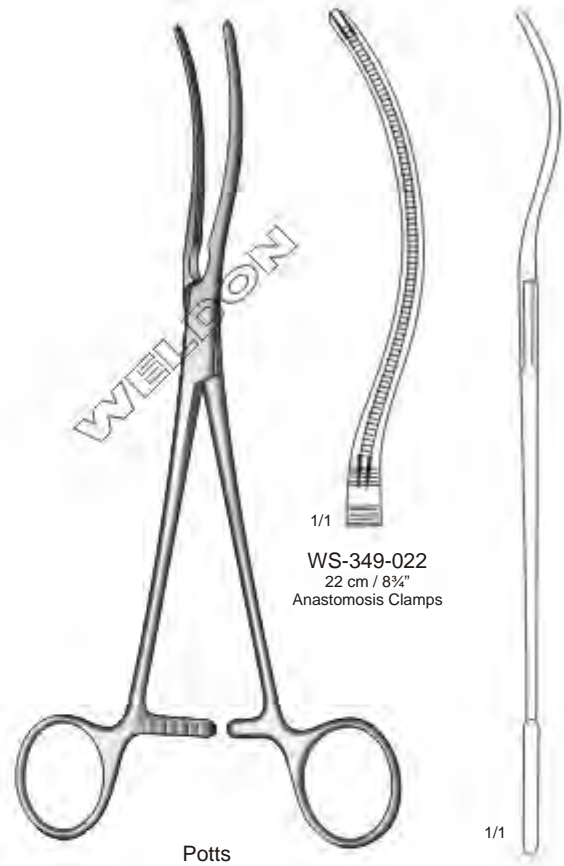

WS-349-022
22 cm / 8 3/4"
Anastomosis Clamps



DeBakey
Dissecting & Ligature Forceps



WS-349-023
19 cm / 7 1/2"

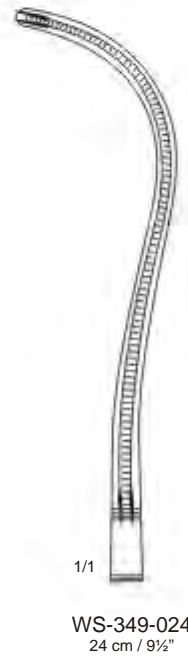

WS-349-024
24 cm / 9 1/2"

Cardiovascular Forceps | Pinzas Cardiovasculares | Gefäßklemmen

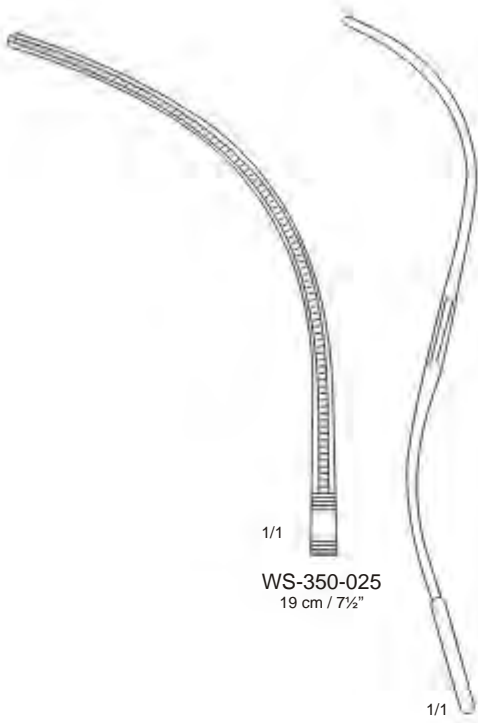

WS-350-025
19 cm / 7½"



DeBakey
Peripheral Vascular Clamps

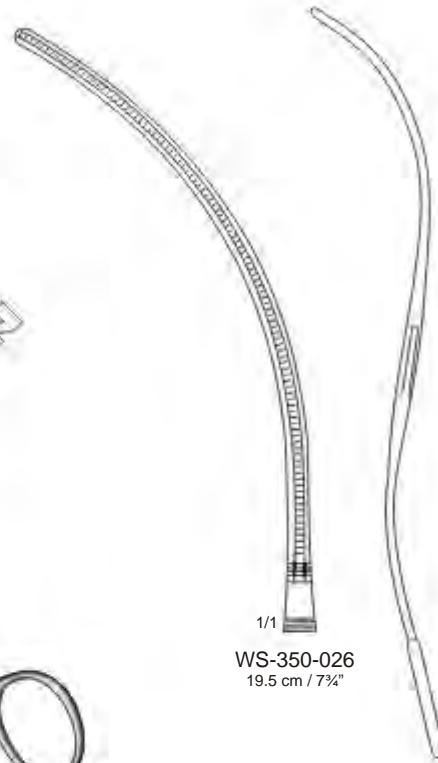

WS-350-026
19.5 cm / 7¾"

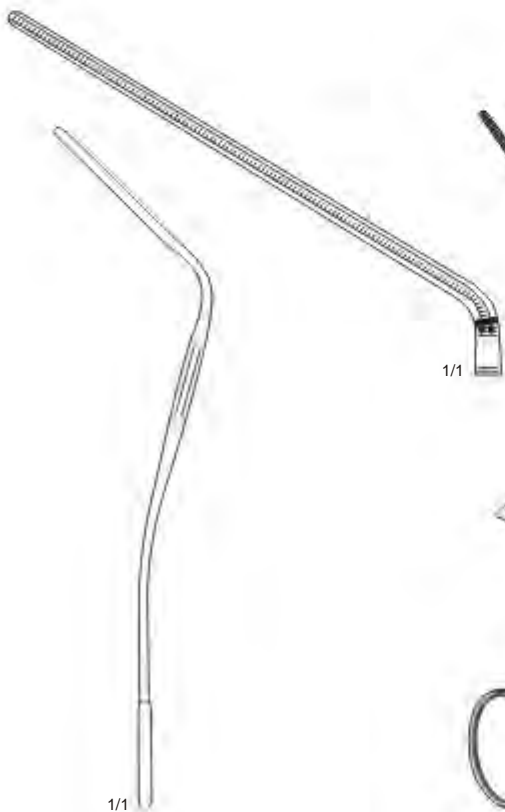

WS-350-027
18 cm / 7"



Leland-Jones
Peripheral Vascular Clamps

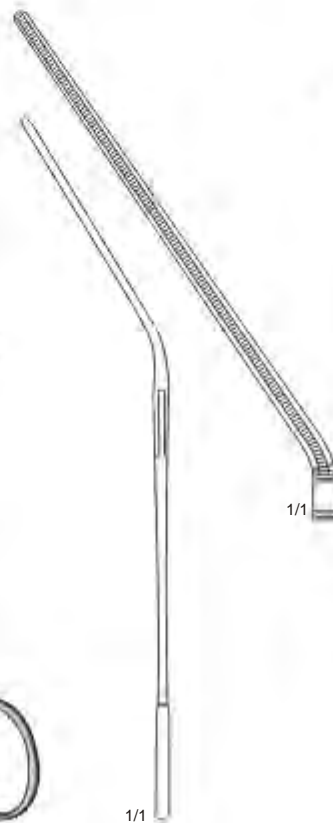

WS-350-028
18.5 cm / 7¼"

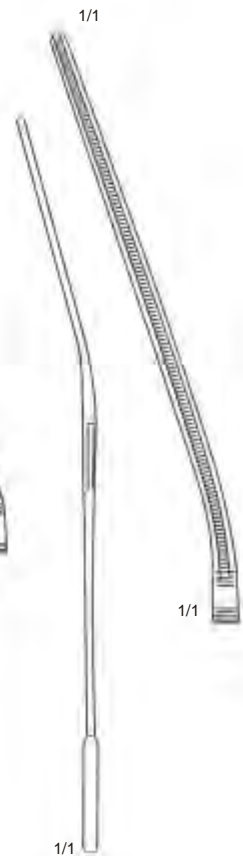

WS-350-029
19.5 cm / 7¾"

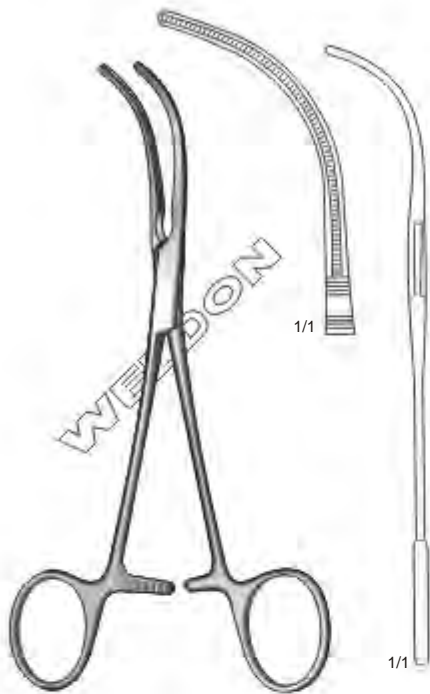

DeBakey
WS-351-030
 16 cm / 6 1/4"
 Peripheral Vascular Clamps



Brainbridge
 Multi Purpose Vascular Clamps

WS-351-031
 15 cm / 6"

WS-351-032
 18.5 cm / 7 1/4"

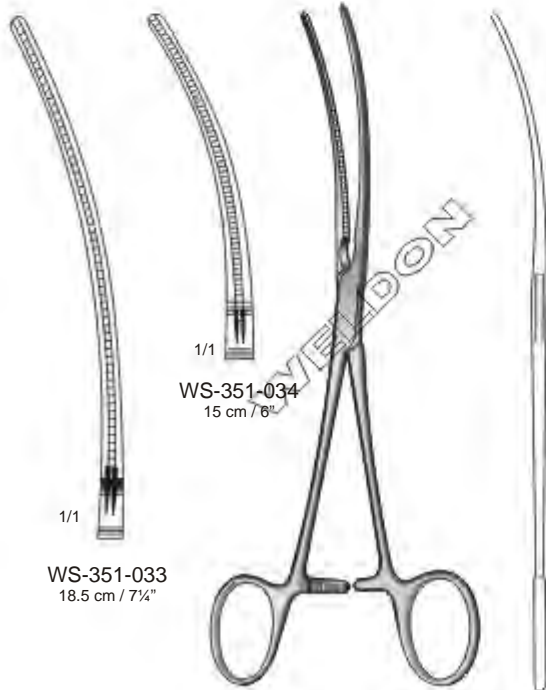

WS-351-034
 15 cm / 6"

WS-351-033
 18.5 cm / 7 1/4"

Brainbridge
 Multi Purpose Vascular Clamps

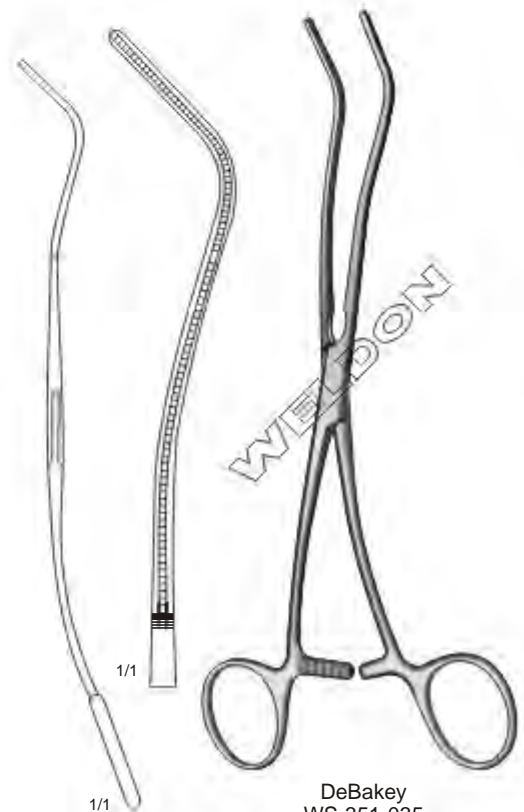

DeBakey
WS-351-035
 20 cm / 8"
 Multi Purpose Vascular Clamps

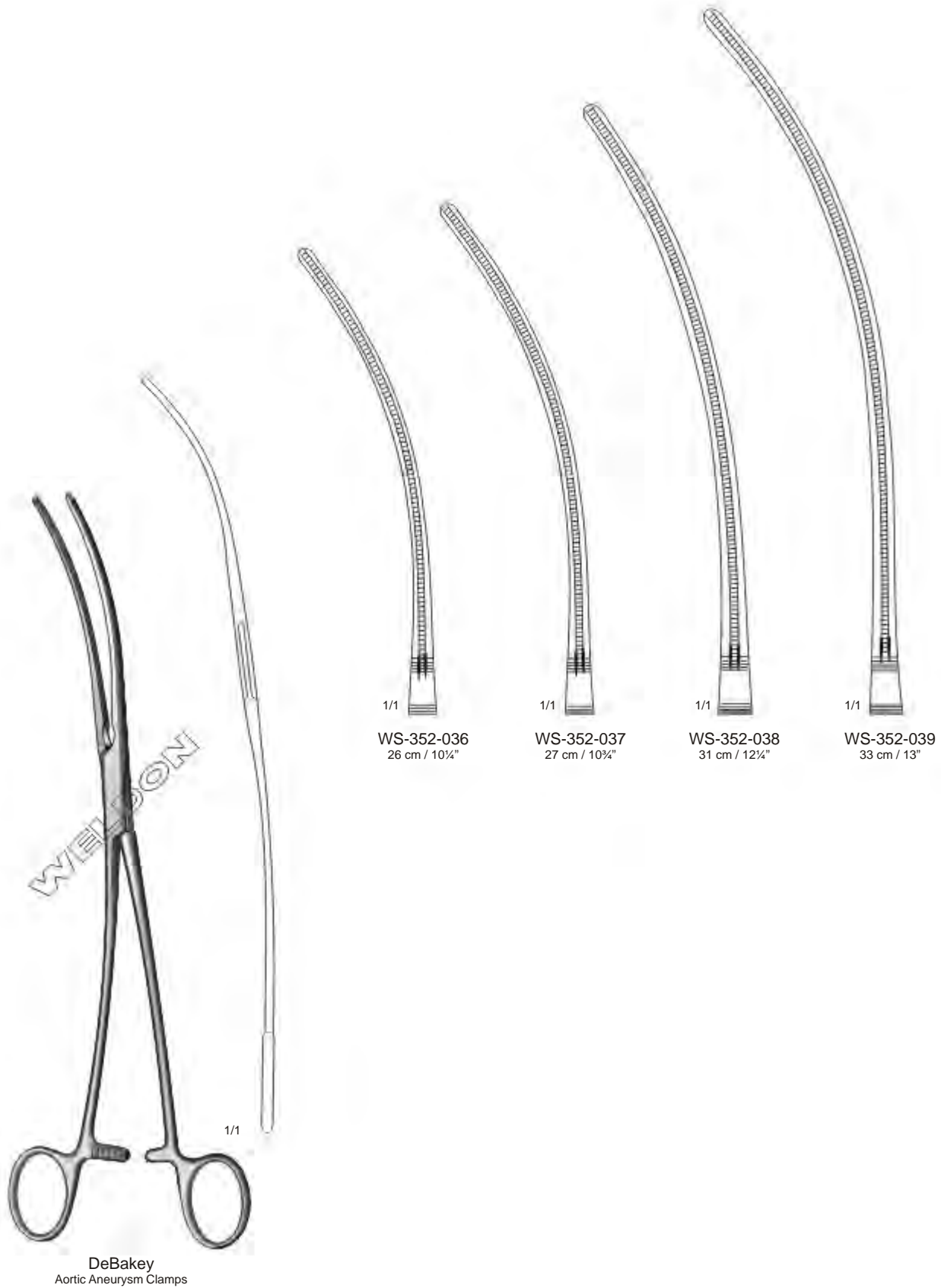

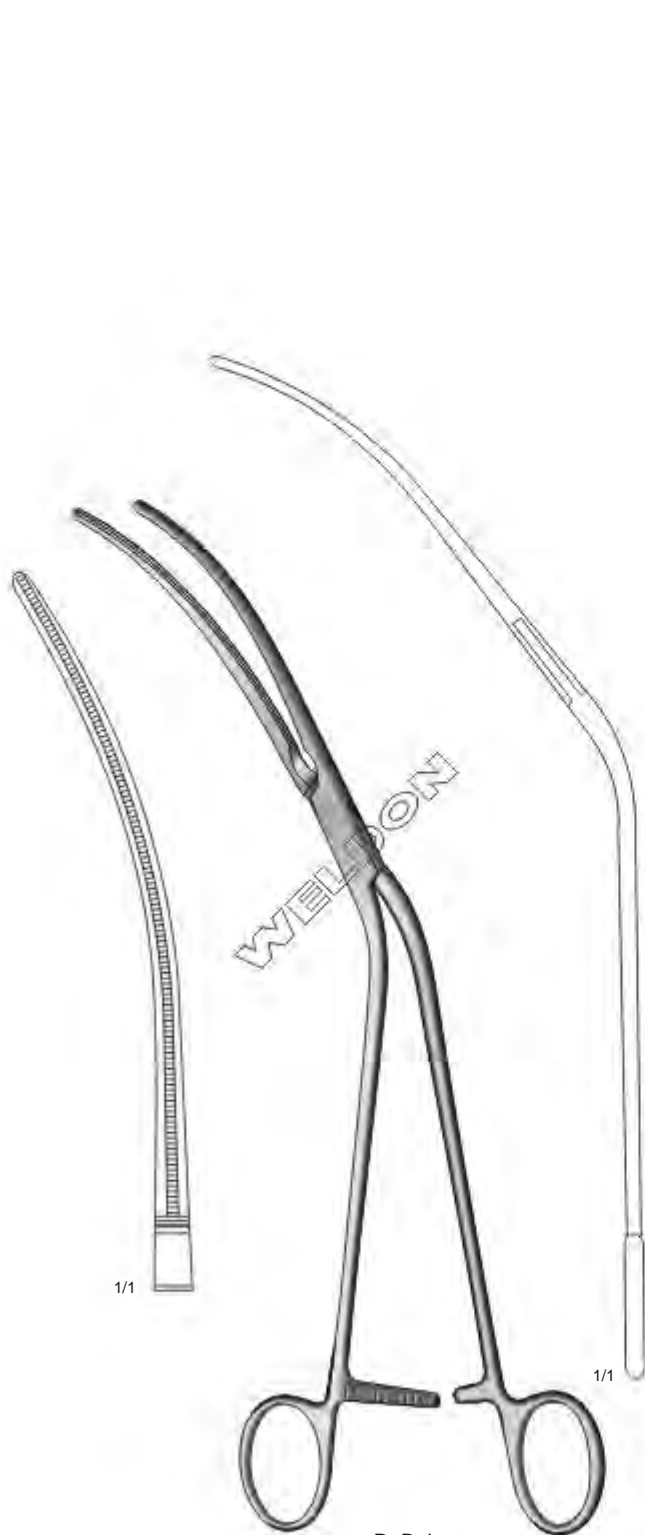

DeBakey
WS-353-040
28 cm / 11"
Aortic Aneurysm Clamps

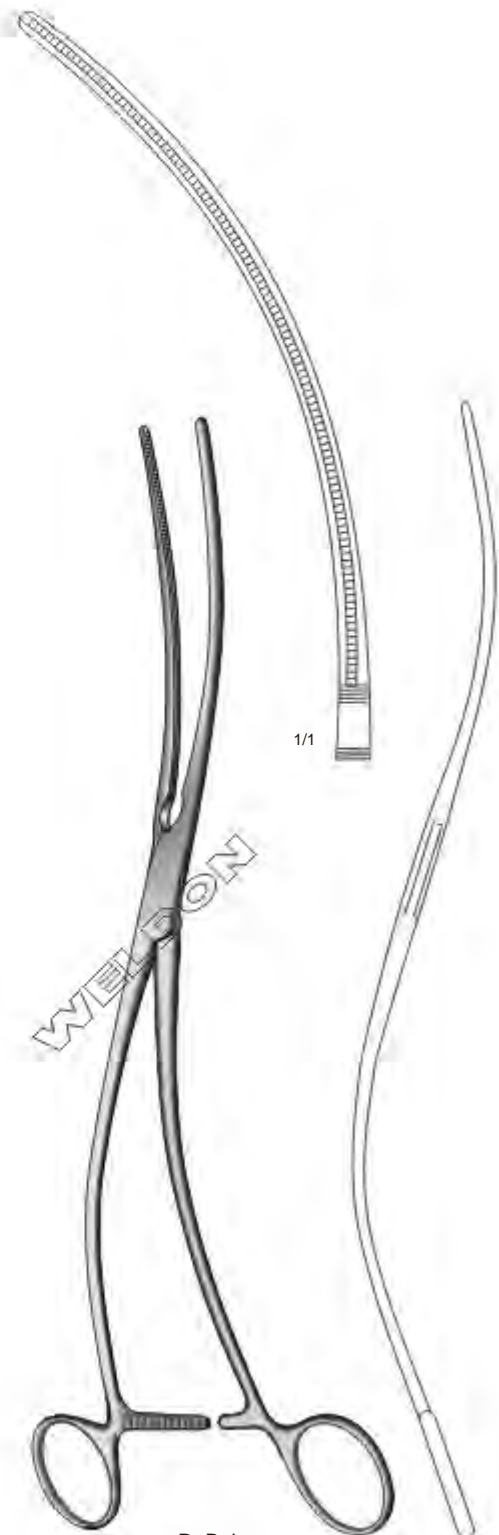

DeBakey
WS-353-041
30 cm / 11 1/2"
Aortic Aneurysm Clamps

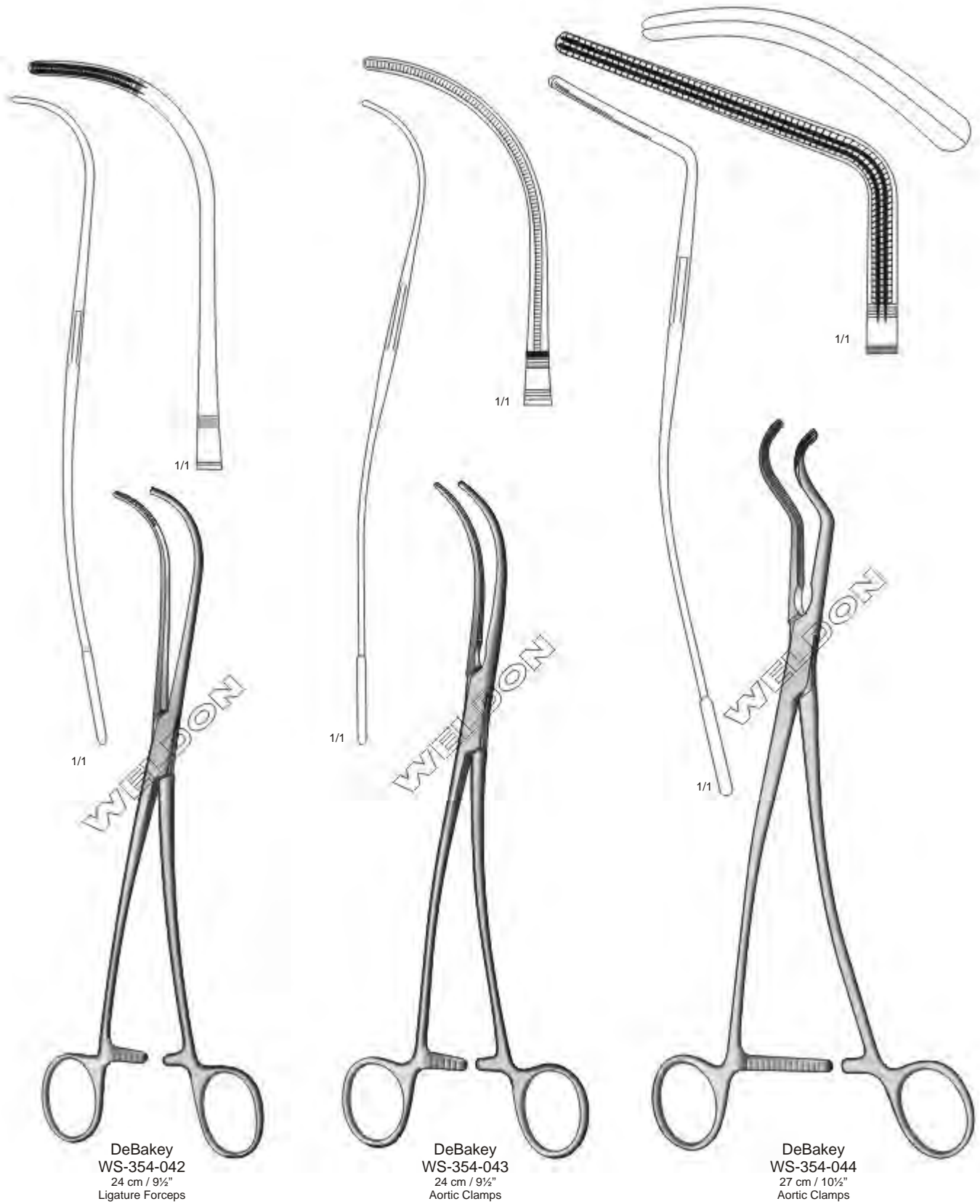

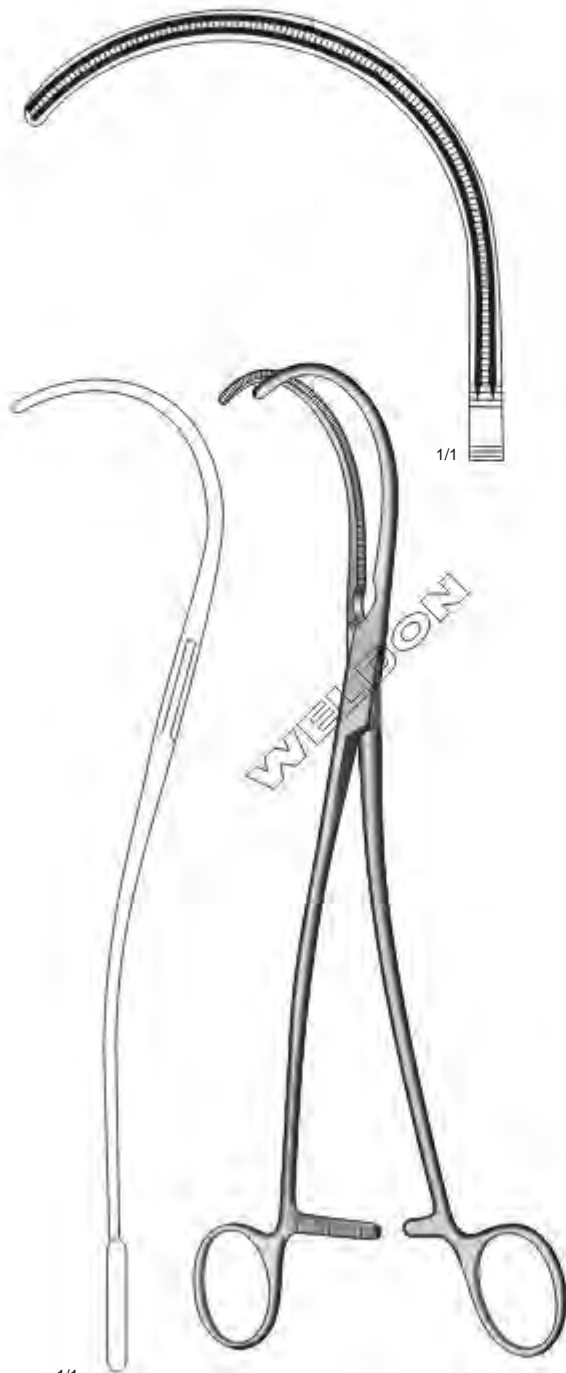

DeBakey
WS-355-045
27 cm / 10½"
Aortic Clamps



DeBakey
WS-355-046
27 cm / 10½"
Ligature Forceps

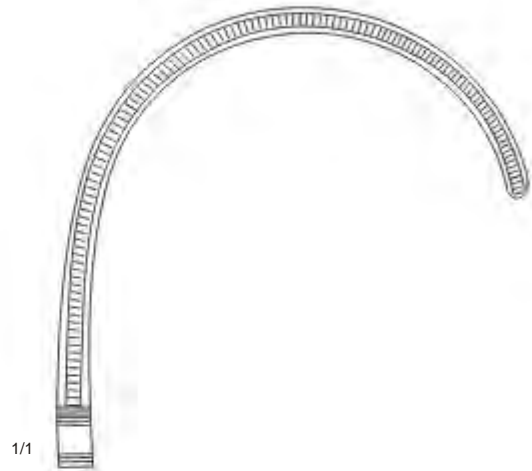
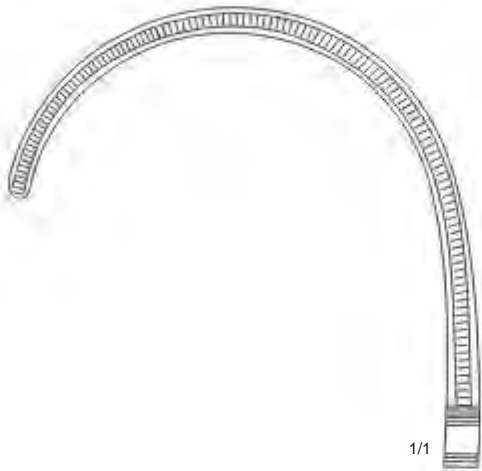

Weber
WS-356-047
24 cm / 9½"
Aortic Clamps
Left

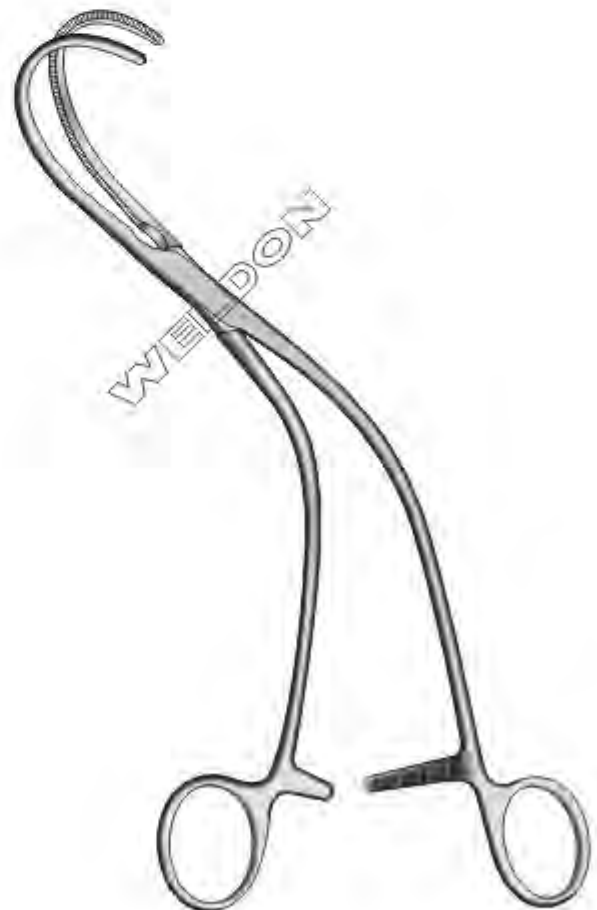

Weber
WS-356-048
24 cm / 9½"
Aortic Clamps
Right

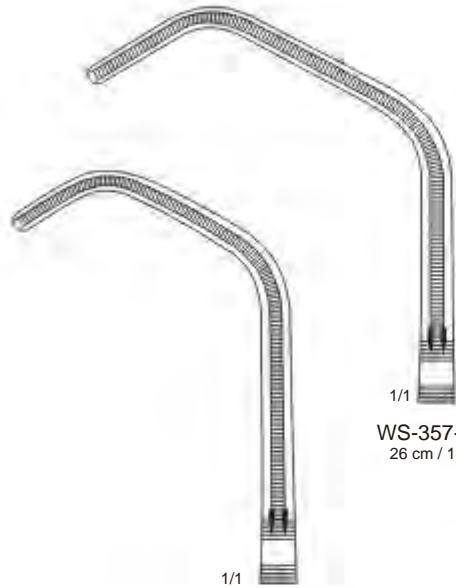

1/1
WS-357-050
26 cm / 10¼"

1/1
WS-357-049
22 cm / 8¾"



1/1
WS-357-051
26.5 cm / 10½"

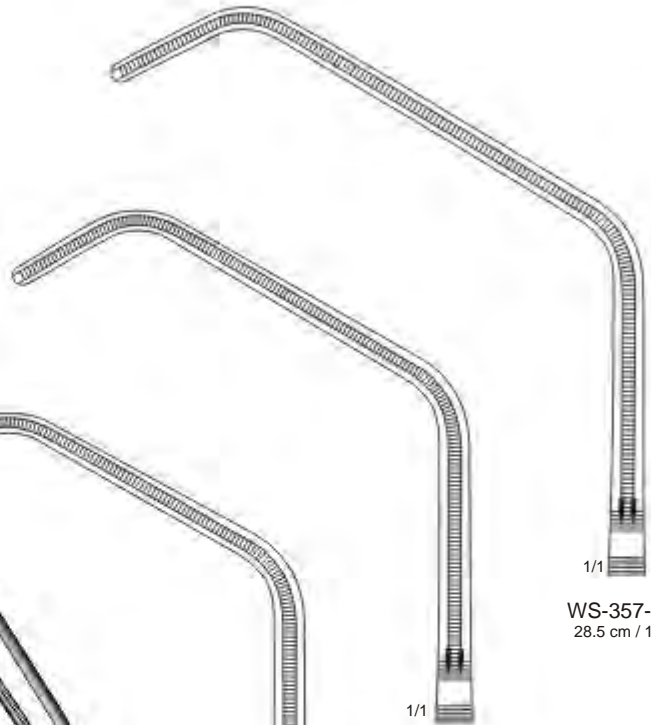

1/1
WS-357-052
27.5 cm / 10¾"

1/1
WS-357-053
28.5 cm / 11¼"



1/1



WELDON

Satinsky
Tangential Occlusion Clamps

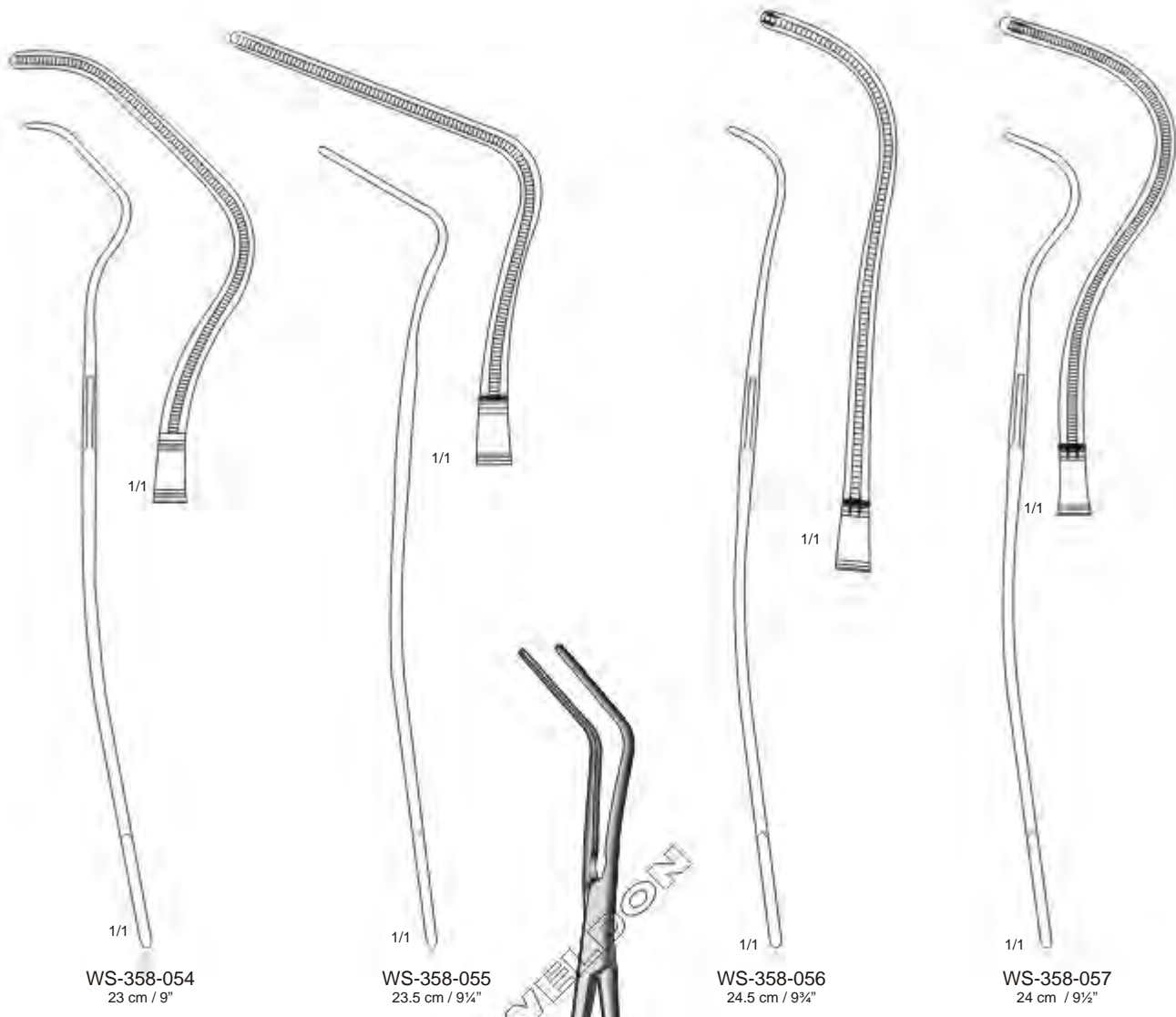

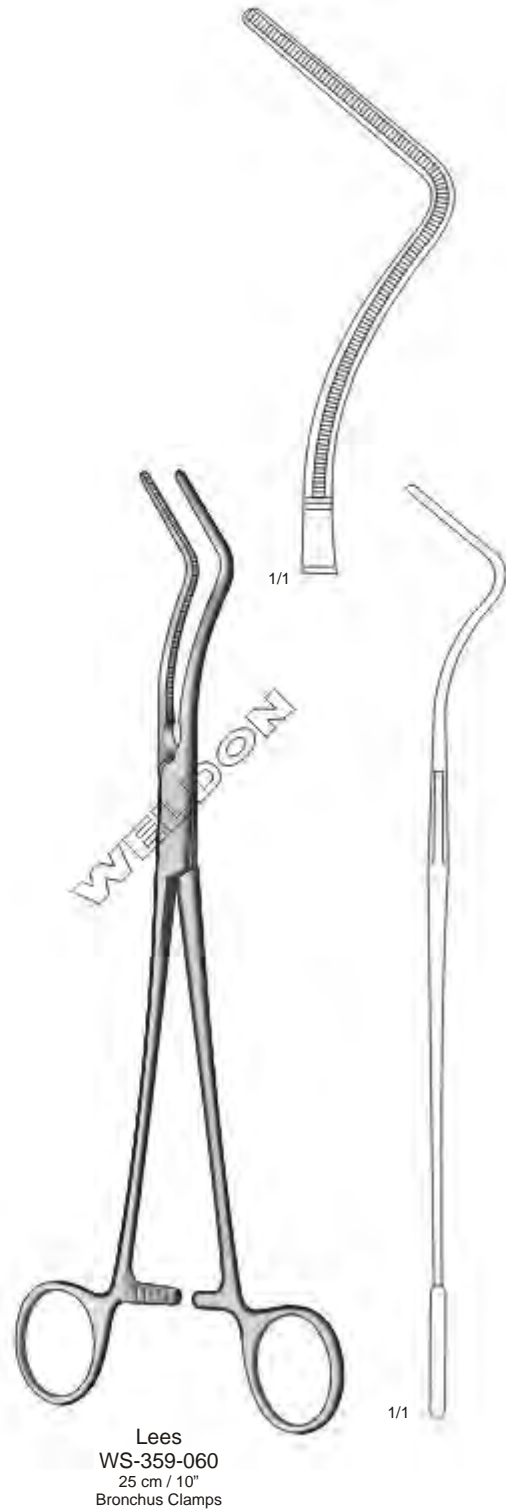
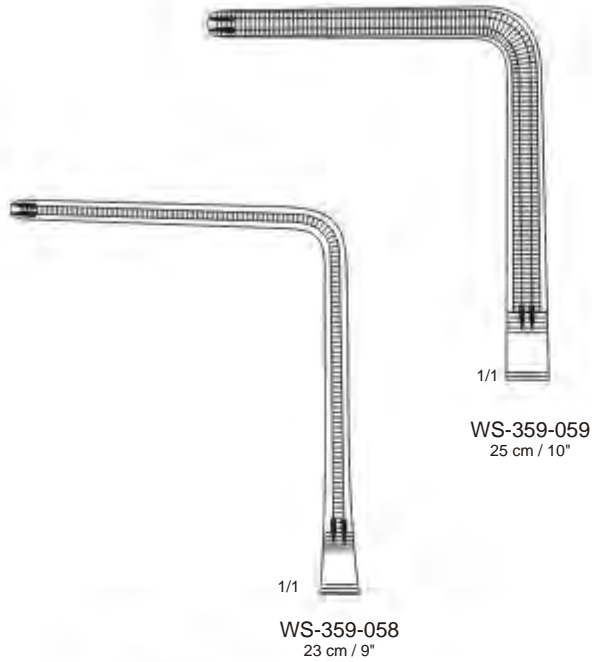

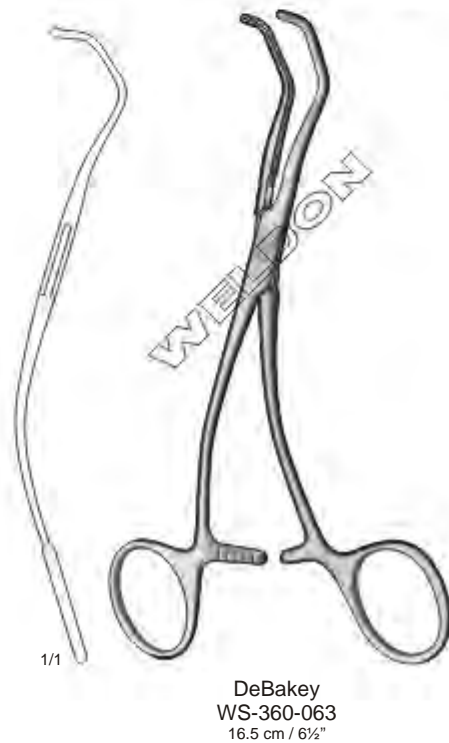
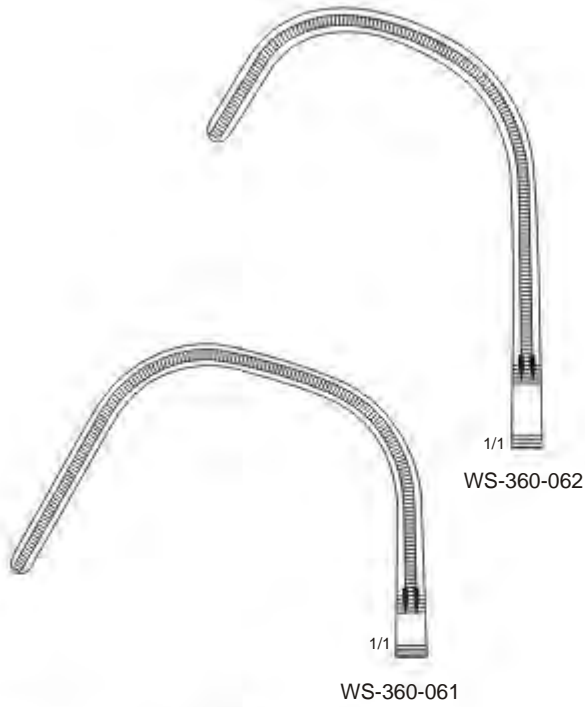

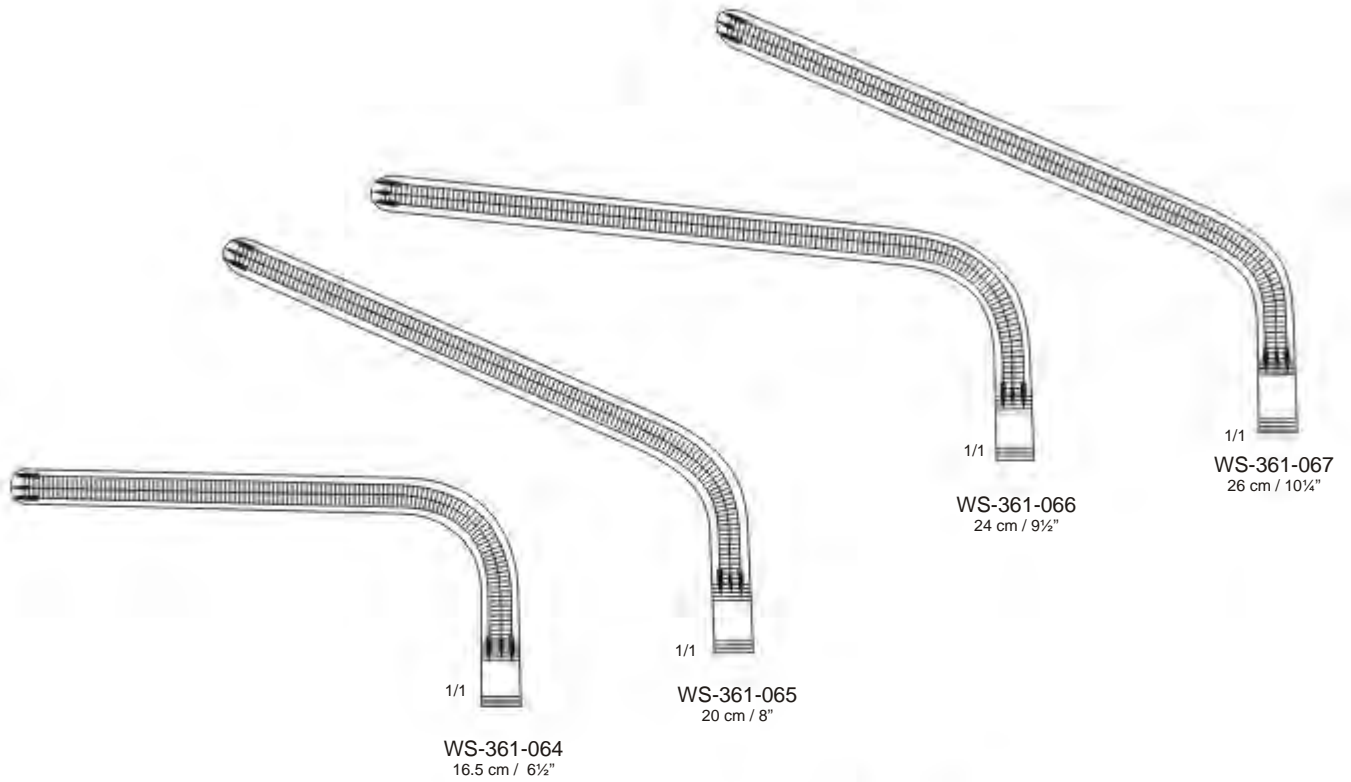

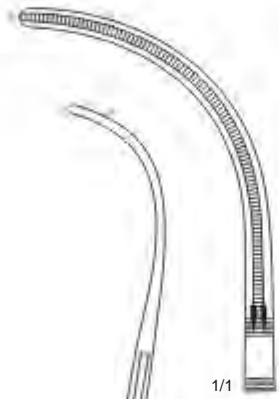

1/1
WS-362-068
23.5 cm / 9"

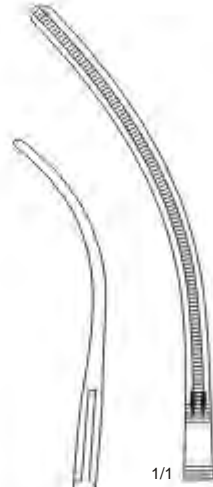

1/1
WS-362-069
24 cm / 9½"

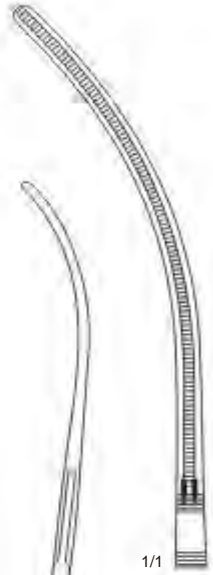

1/1
WS-362-070
25.5 cm / 10"



DeBakey-Bahnon
Aneurysm Clamps

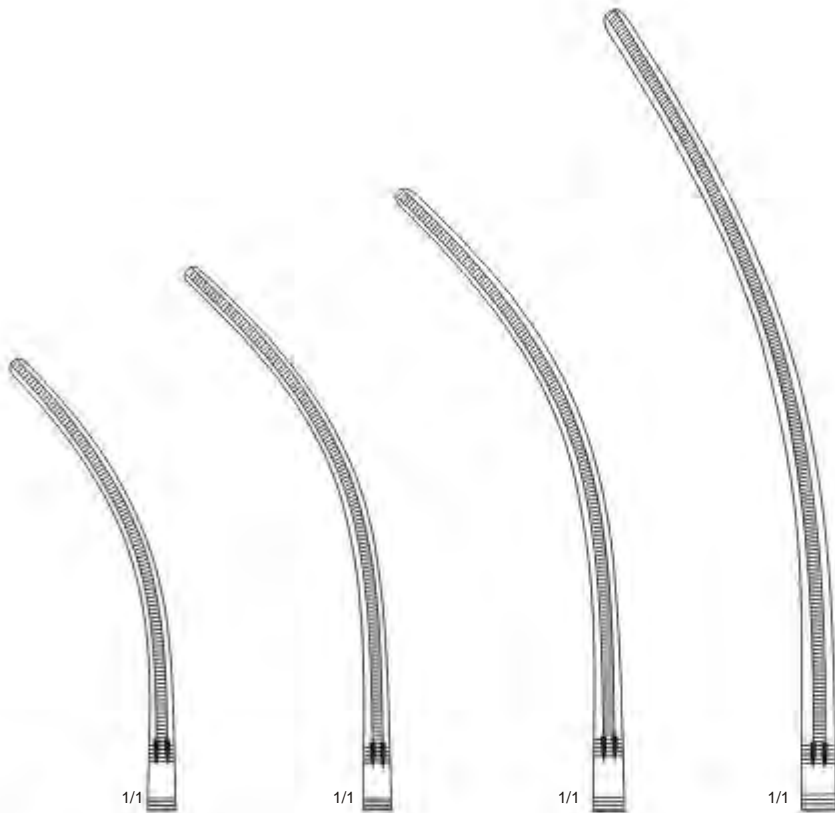

1/1
WS-363-071
21.5 cm / 8½"

1/1
WS-363-072
23 cm / 9"

1/1
WS-363-073
26 cm / 10¼"

1/1
WS-363-074
31.5 cm / 12½"



Potts
Multi Purpose Vascular Clamps

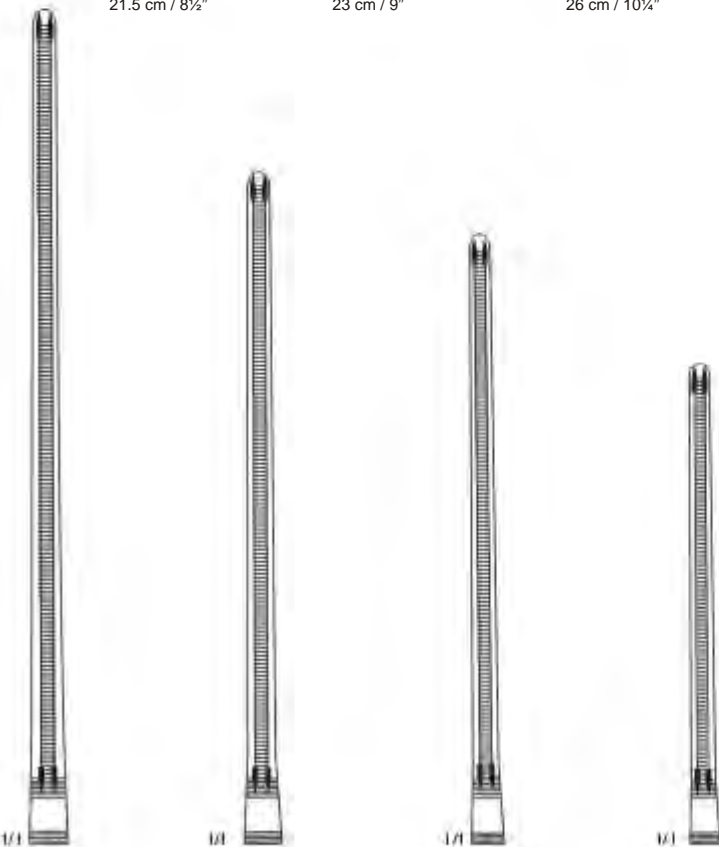

1/1
WS-363-075
31.5 cm / 12½"

1/1
WS-363-076
27 cm / 10½"

1/1
WS-363-077
23.5 cm / 9"

1/1
WS-363-078
21.5 cm / 8½"



Potts
Multi Purpose Vascular Clamps

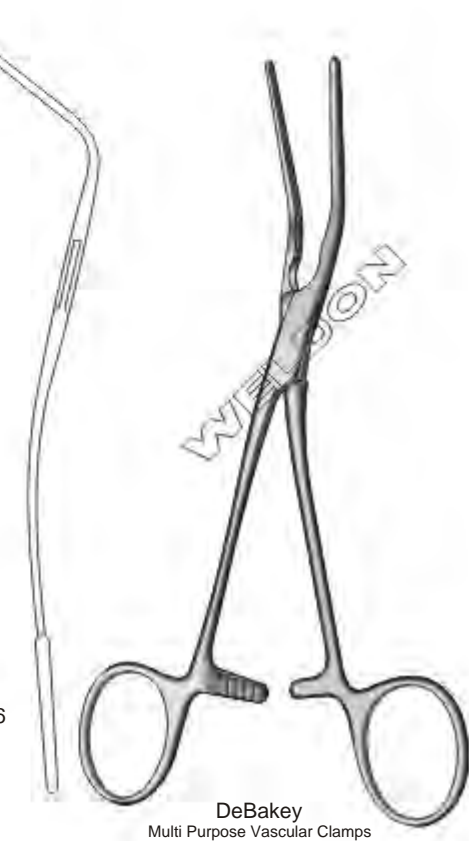
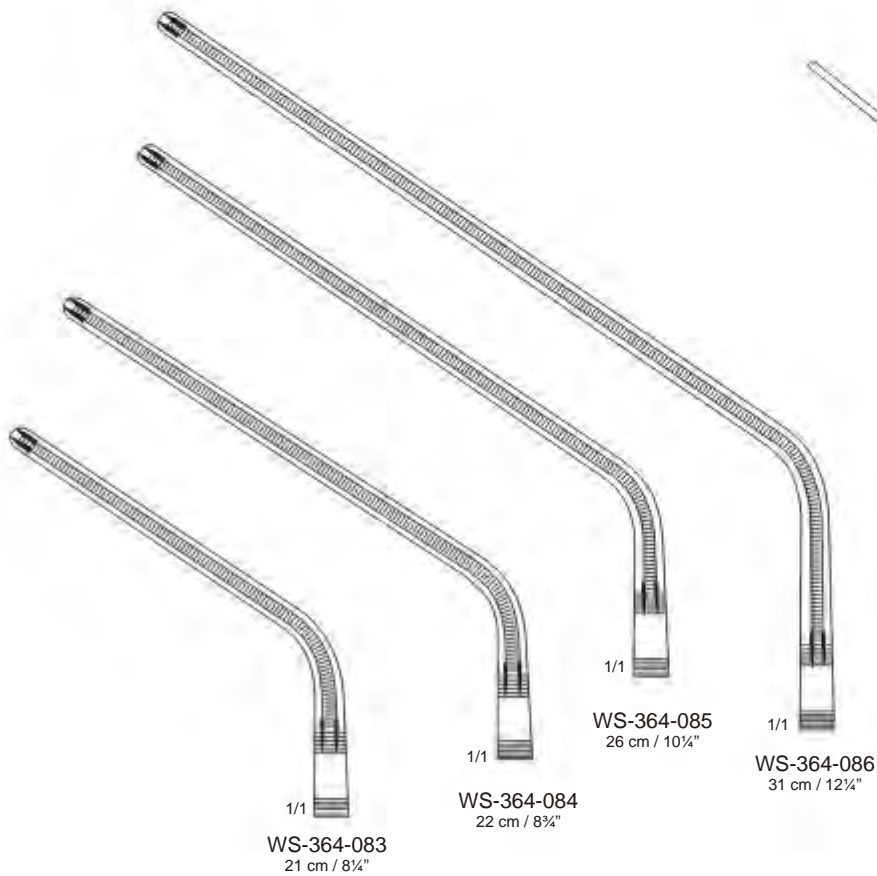
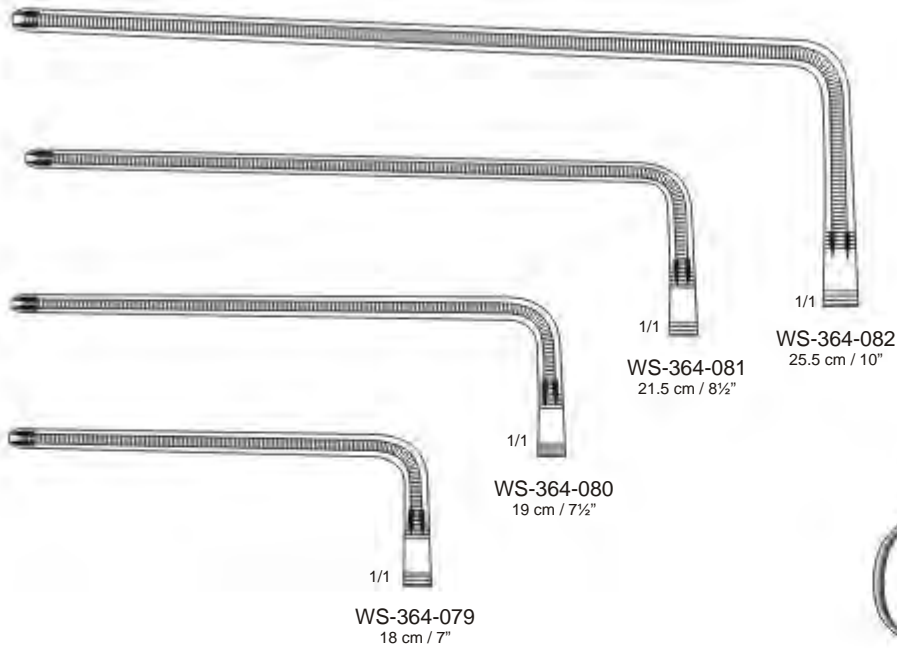

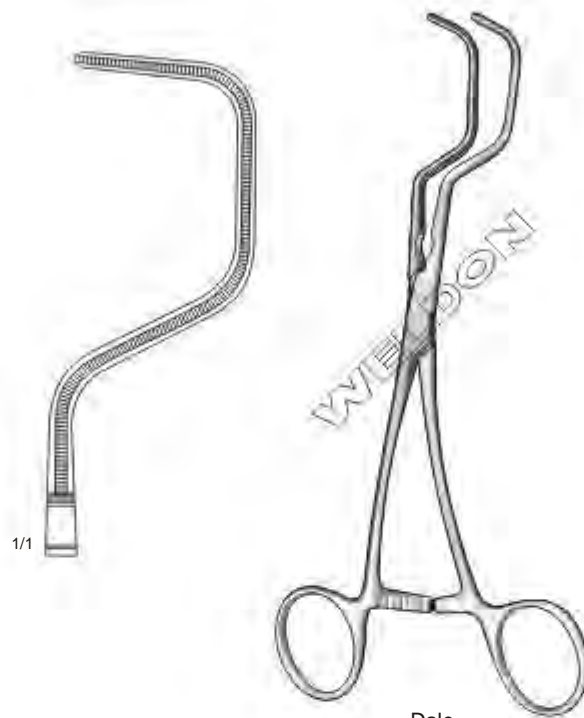

Dale
WS-365-087
18.5 cm / 7 1/4"
Peripheral Vascular Clamps

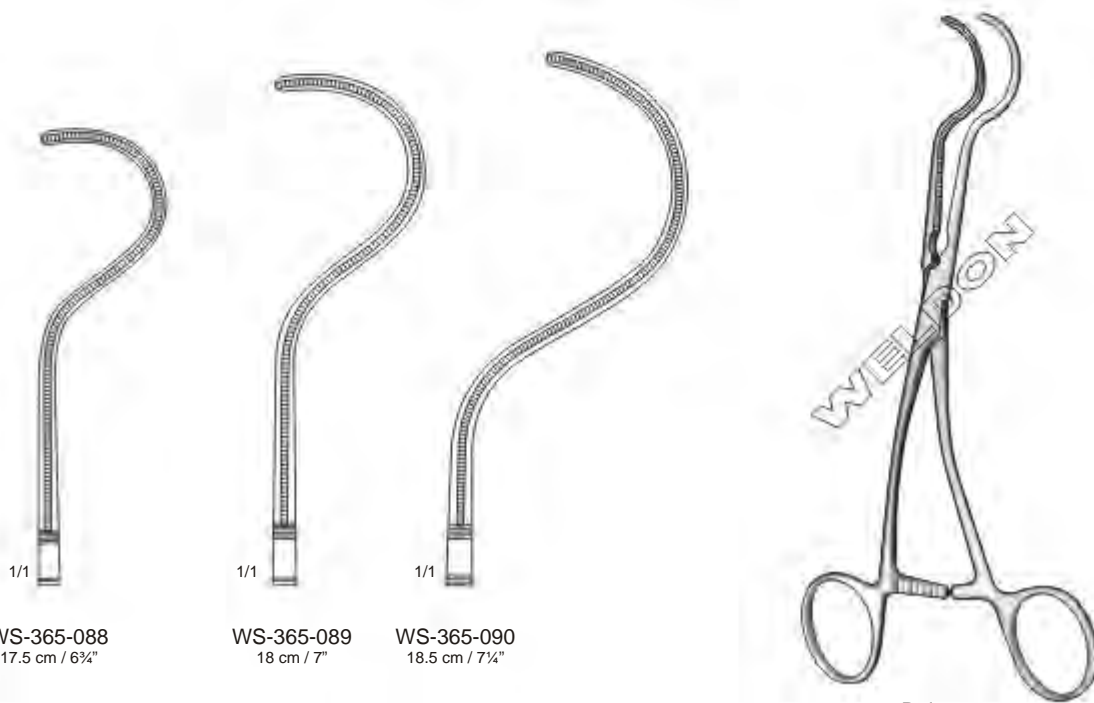

WS-365-088
17.5 cm / 6 3/4"

WS-365-089
18 cm / 7"

WS-365-090
18.5 cm / 7 1/4"

Dale
Peripheral Vascular Clamps



DeBakey
WS-366-091
16 cm / 6 1/4"
Multi Purpose Vascular Clamps



DeBakey
WS-366-092
14.5 cm / 5 3/4"
Multi Purpose Vascular Clamps

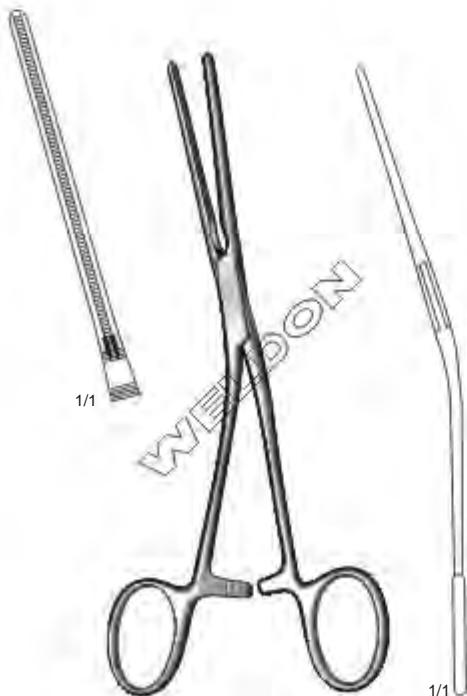

DeBakey
WS-366-093
16.5 cm / 6 1/2"
Multi Purpose Vascular Clamps

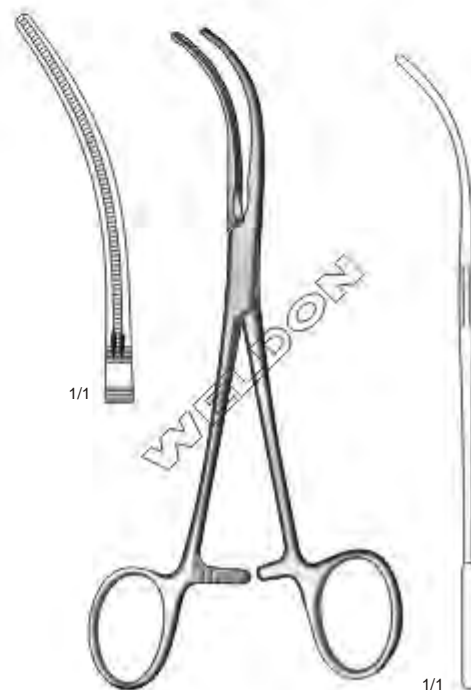

Glover
WS-366-094
17 cm / 6 3/4"
Multi Purpose Vascular Clamps

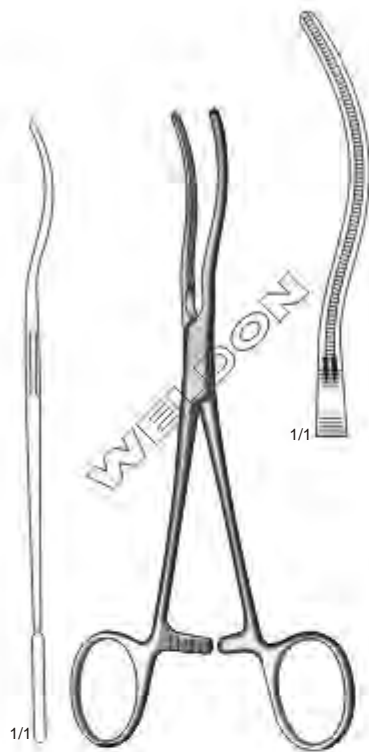

Glover
WS-367-095
 17 cm / 6 3/4"
 Multi Purpose Vascular Clamps

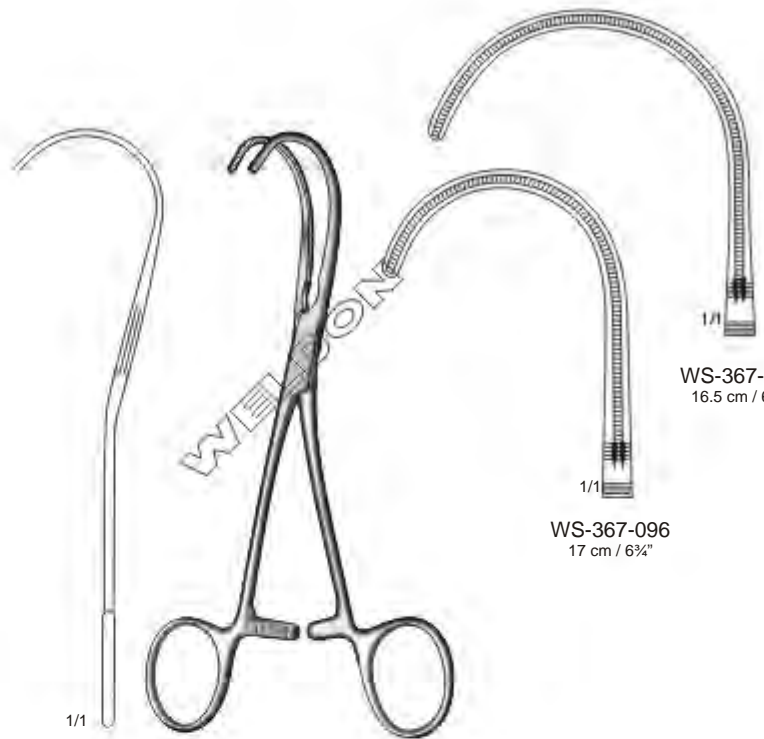

DeBakey
 Multi Purpose Vascular Clamps

WS-367-097
 16.5 cm / 6 1/2"

WS-367-096
 17 cm / 6 3/4"



Beck
WS-367-098
 17 cm / 6 3/4"
 Anastomosis Clamps

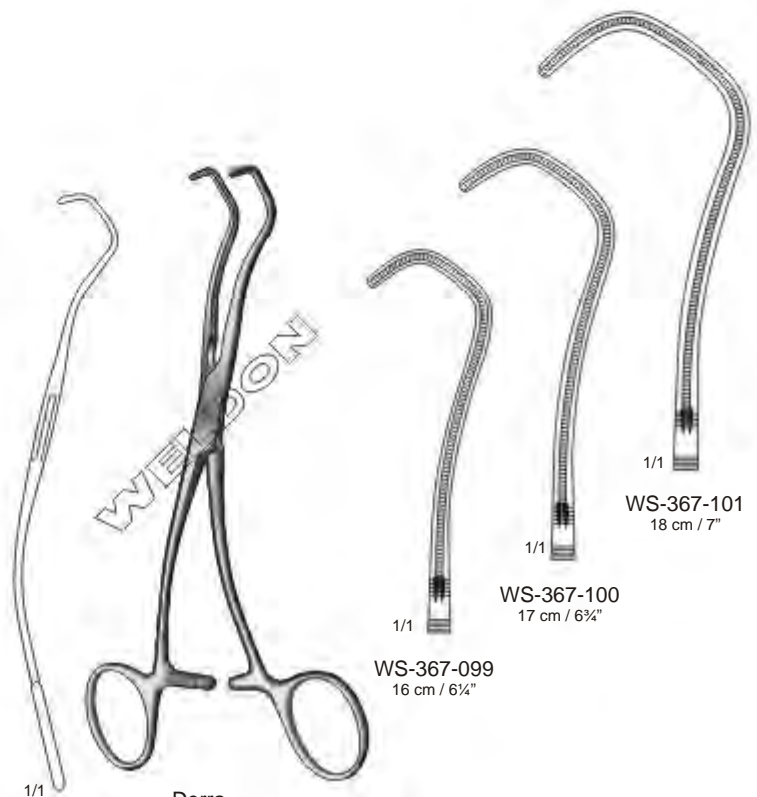

Derra
 Anastomosis Clamps

WS-367-099
 16 cm / 6 1/4"

WS-367-100
 17 cm / 6 3/4"

WS-367-101
 18 cm / 7"



DeBakey
WS-368-102
10 cm / 4"
Pediatric Vascular Clamps



DeBakey
WS-368-103
12.5 cm / 5"
Pediatric Vascular Clamps



DeBakey
WS-368-104
12.5 cm / 5"
Pediatric Vascular Clamps



DeBakey
WS-368-105
12.5 cm / 5"
Pediatric Vascular Clamps

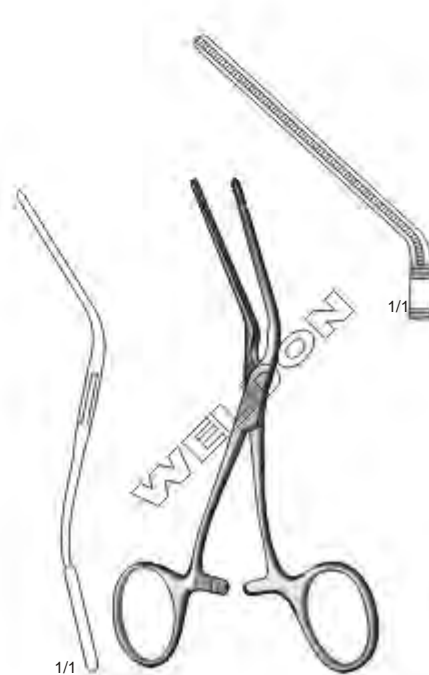

DeBakey
WS-368-106
12.5 cm / 5"
Pediatric Vascular Clamps

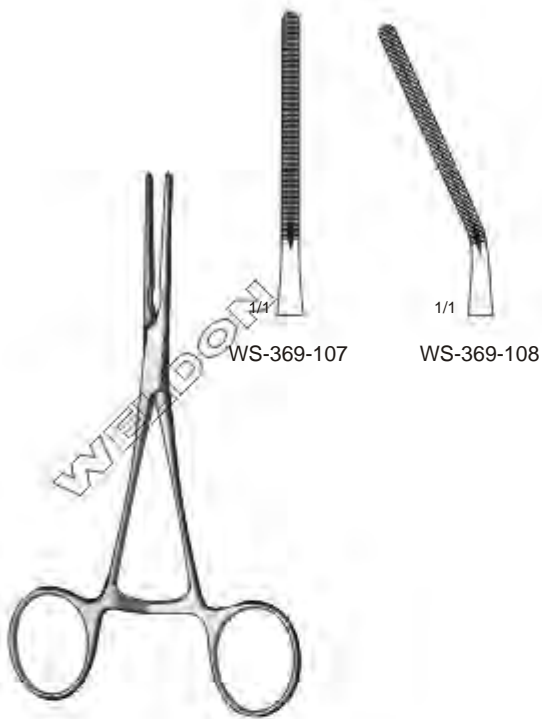

Cooley
14.5 cm / 5 3/4"
Pediatric Vascular Clamps



Cooley
14 cm / 5 1/2"
Pediatric Vascular Clamps



Cooley
14 cm / 5 1/2"
Pediatric Vascular Clamps



Cooley
14 cm / 5 1/2"
Pediatric Vascular Clamps

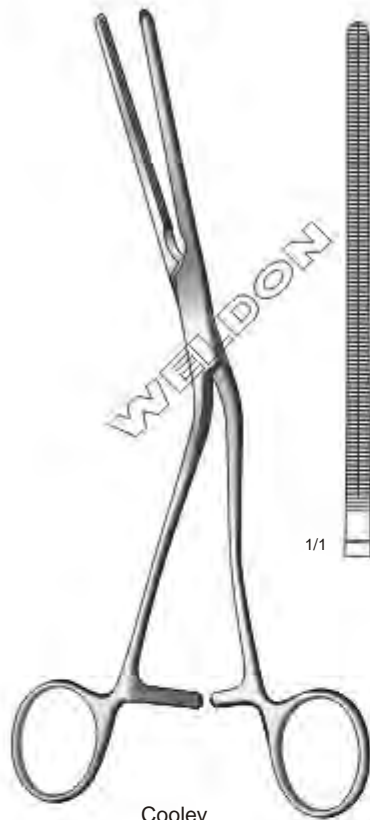

Cooley
WS-370-112
22 cm / 8 3/4"
Iliac Clamps



Cooley
WS-370-113
20 cm / 8"
Carotid Clamps



DeBakey
WS-370-114 20 cm / 8"
WS-370-115 22 cm / 9"
Hysterectomy Clamps



DeBakey
WS-370-116
17 cm / 6 3/4"

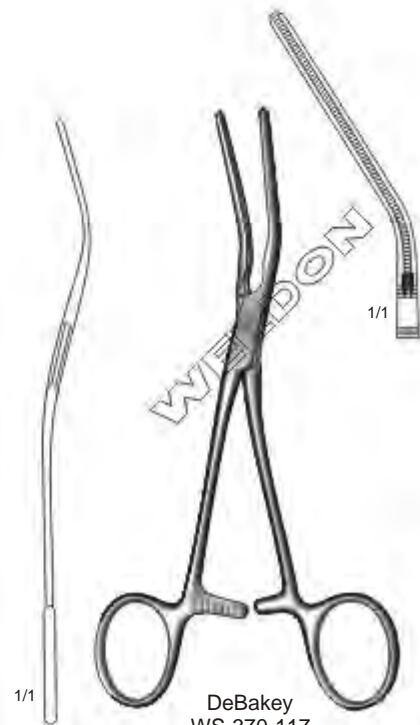

DeBakey
WS-370-117
16 cm / 6 1/4"

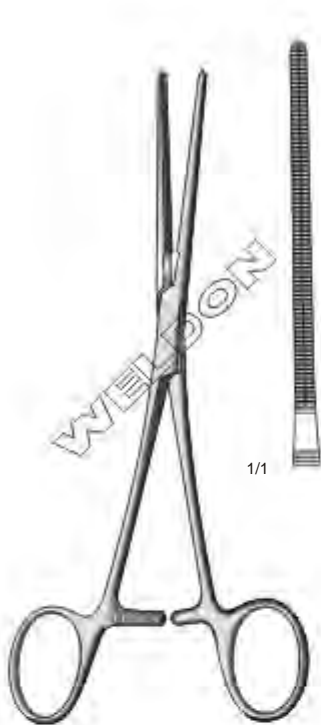

Cooley
WS-371-118
17 cm / 6 3/4"
Anastomosis Clamps

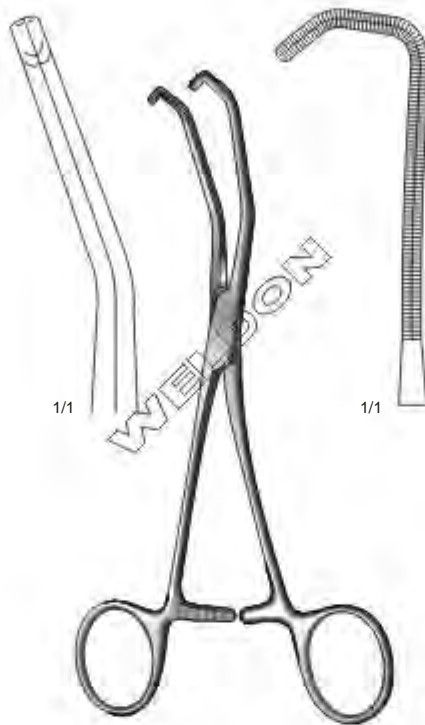

Cooley
WS-371-119
17 cm / 6 3/4"
Anastomosis Clamps

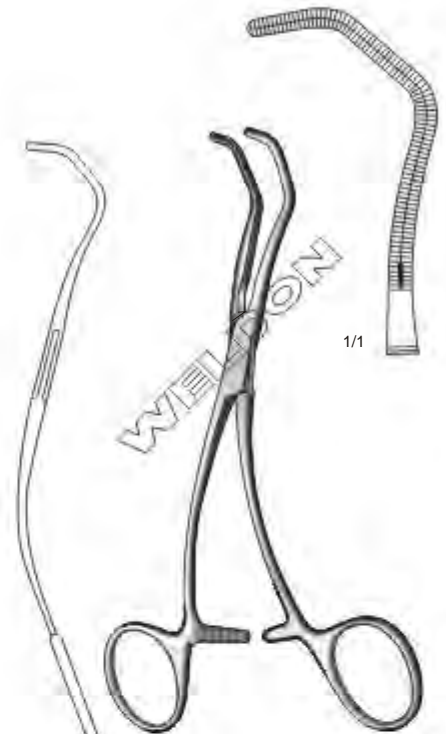

Cooley
WS-371-120
16 cm / 6 1/4"
Anastomosis Clamps



Cooley
WS-371-121
14 cm / 5 1/2"
Multi Purpose Vascular Clamps

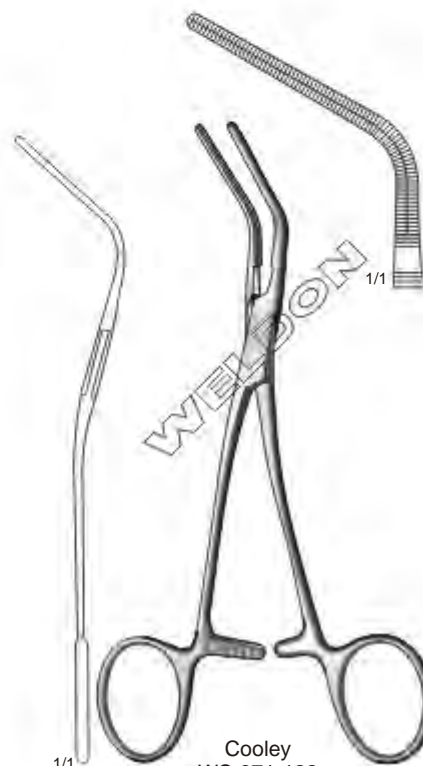

Cooley
WS-371-122
15.5 cm / 6 1/8"
Multi Purpose Vascular Clamps

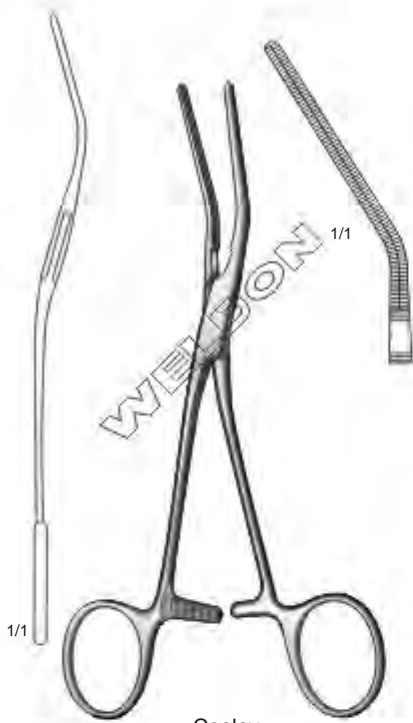

Cooley
WS-372-123
17 cm / 6 $\frac{3}{4}$ "
Multi Purpose Vascular Clamps



Cooley
WS-372-124
17 cm / 6 $\frac{3}{4}$ "
Multi Purpose Vascular Clamps

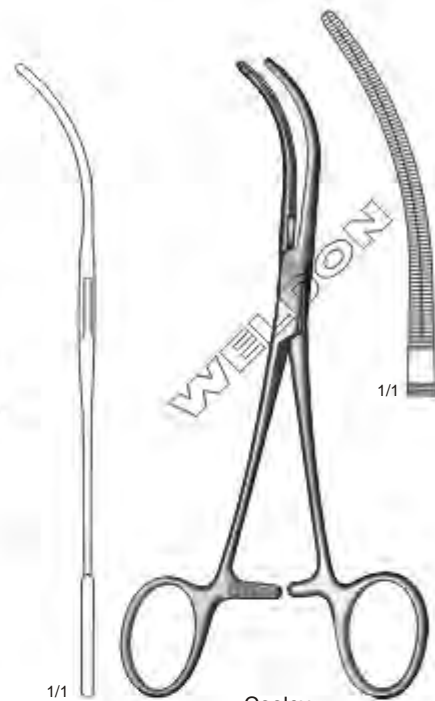

Cooley
WS-372-125
17 cm / 6 $\frac{3}{4}$ "
Multi Purpose Vascular Clamps

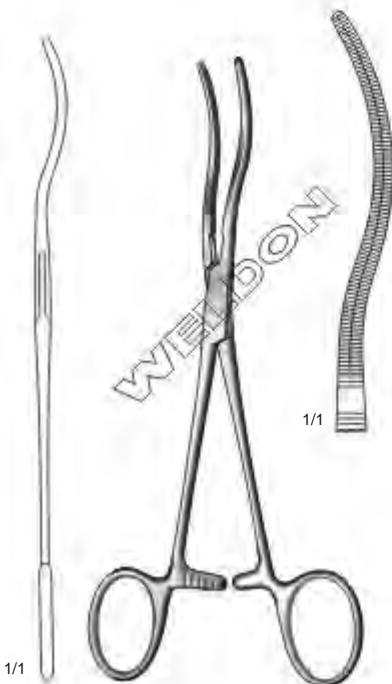

Cooley
WS-372-126
17.5 cm / 7"
Multi Purpose Vascular Clamps



WS-372-127
16 cm / 6 $\frac{1}{4}$ "

WS-372-128
17 cm / 6 $\frac{3}{4}$ "

Lung Grasping Forceps | Pinzas Para Coger el Pulmón | Lungenfasszangen

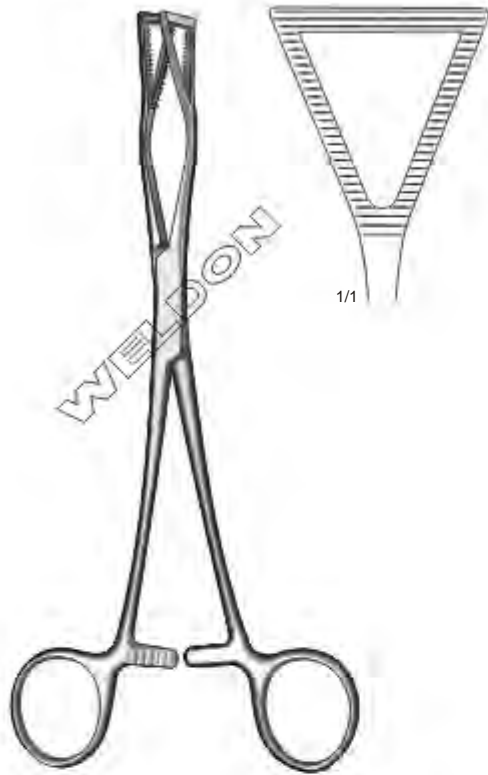

Lovelace
WS-373-129
20.5 cm / 8"

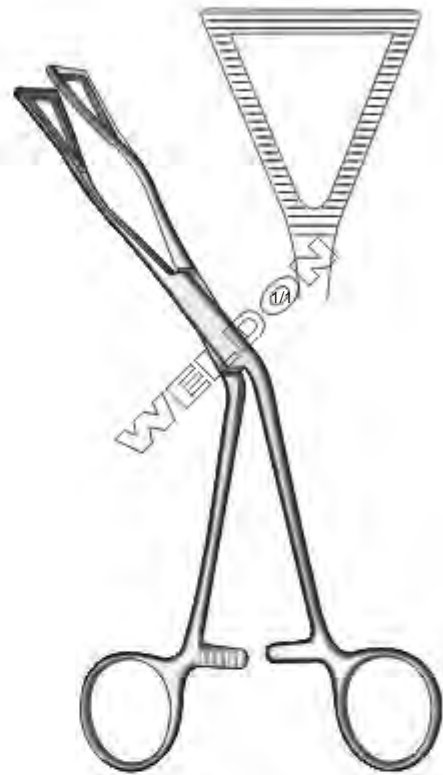

Lovelace
WS-373-130
19 cm / 7½"
Laterally Curved

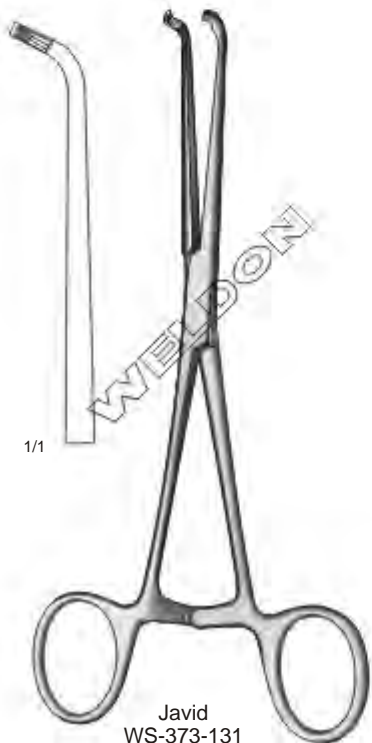

Javid
WS-373-131
17.5 cm / 7"
Carotid Shunt Clamps

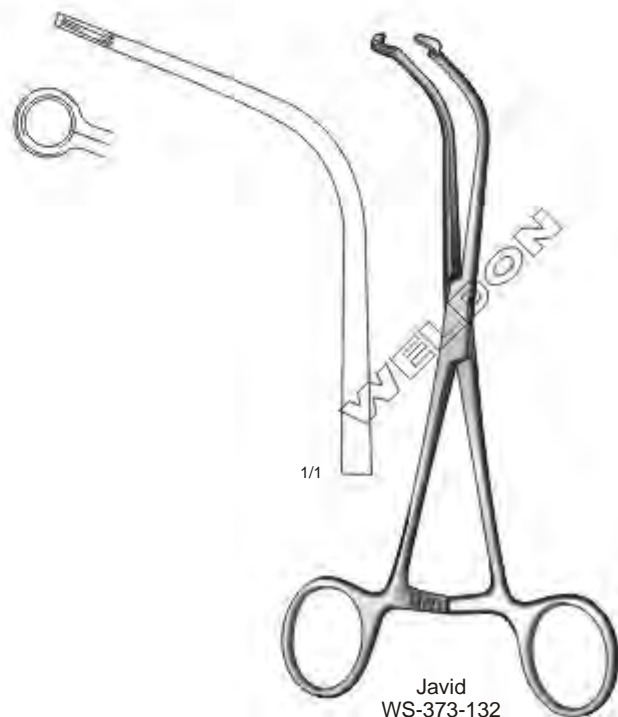

Javid
WS-373-132
18 cm / 7"
Carotid Shunt Clamps



Allison
WS-374-133 29.5 cm / 11½"
WS-374-134 32.5 cm / 12¾"



Allison
WS-374-135
26 cm / 10¼"

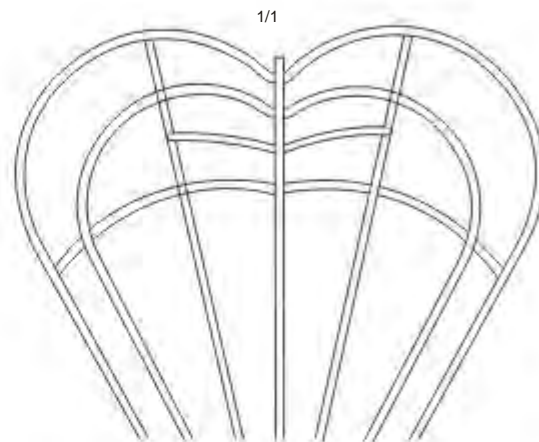

1/1

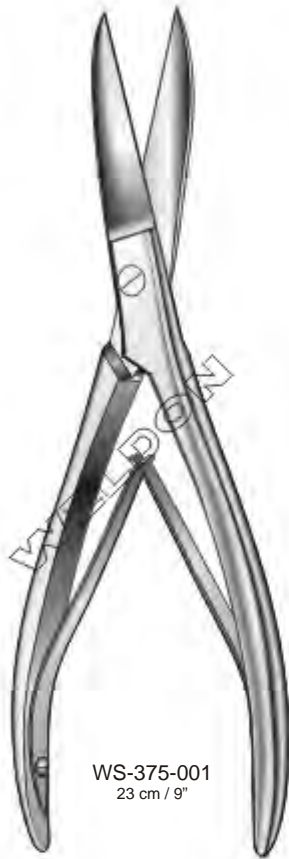

WS-375-001
23 cm / 9"



WS-375-002
22 cm / 8 3/4"



Sauerbruch
WS-375-003 23 cm / 9"
WS-375-004 26 cm / 10 1/4"



Gluck
WS-375-005
22 cm / 8 3/4"



Stille
WS-375-006
21 cm / 8 1/4"

Rib Shears, Sternum Chisel | Costótomos, Cinceles | Rippenscheren, Sternummeißel



Giertz-Stille
WS-376-007
24.5 cm / 9 3/4"

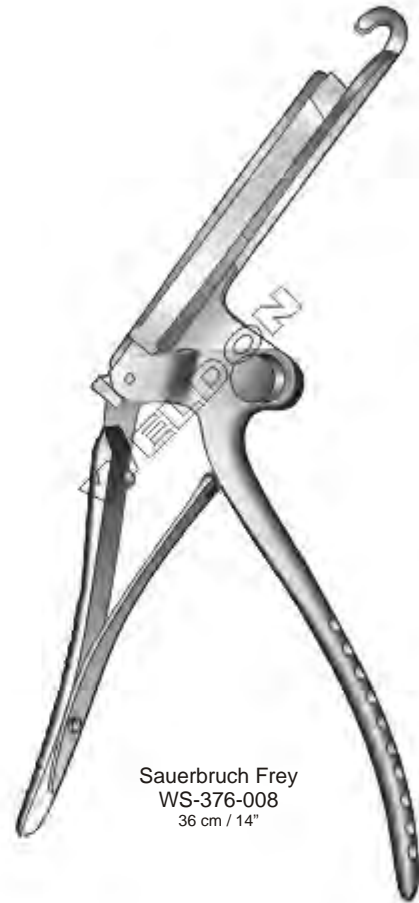

Sauerbruch Frey
WS-376-008
36 cm / 14"



Lebsche
WS-376-009
25 cm / 10"



Brunner
WS-376-010 For Left Hand
WS-376-011 For Right Hand
32 cm / 12 1/2"



Lebsche
WS-376-012
24.5 cm / 9 3/4"

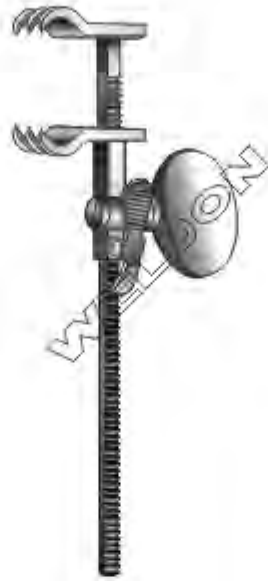

Bailey-Baby
WS-377-001
15.5 cm / 6"



Bailey
WS-377-002
20 cm / 8"
Short Claws

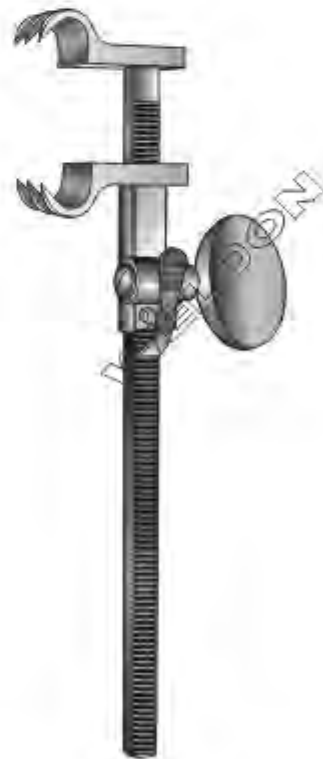

Bailey-Gibbon
WS-377-003
20 cm / 8"
Long Claws

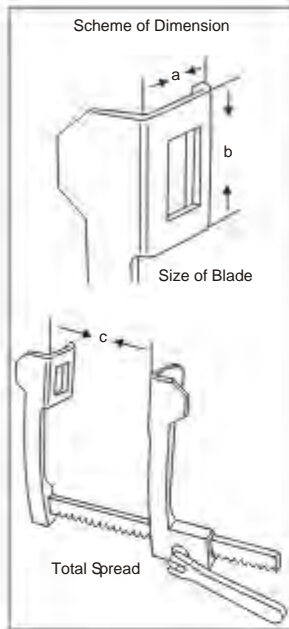

Cooley
WS-378-004
 a = 12 mm, b = 16 mm, c = 95 mm
 For New Born

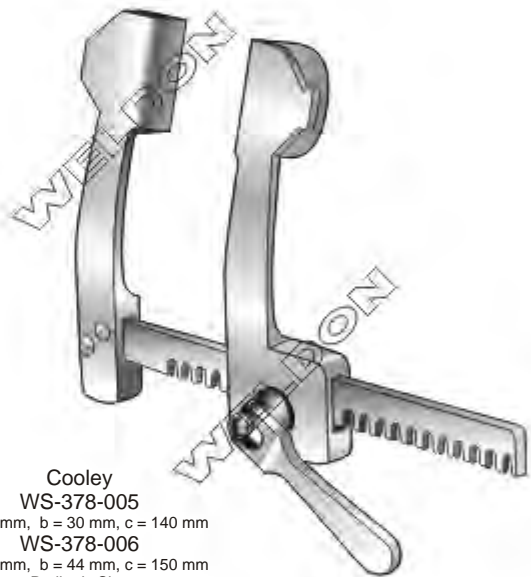

Cooley
WS-378-005
 a = 15 mm, b = 30 mm, c = 140 mm
WS-378-006
 a = 21 mm, b = 44 mm, c = 150 mm
 Pediatric Size

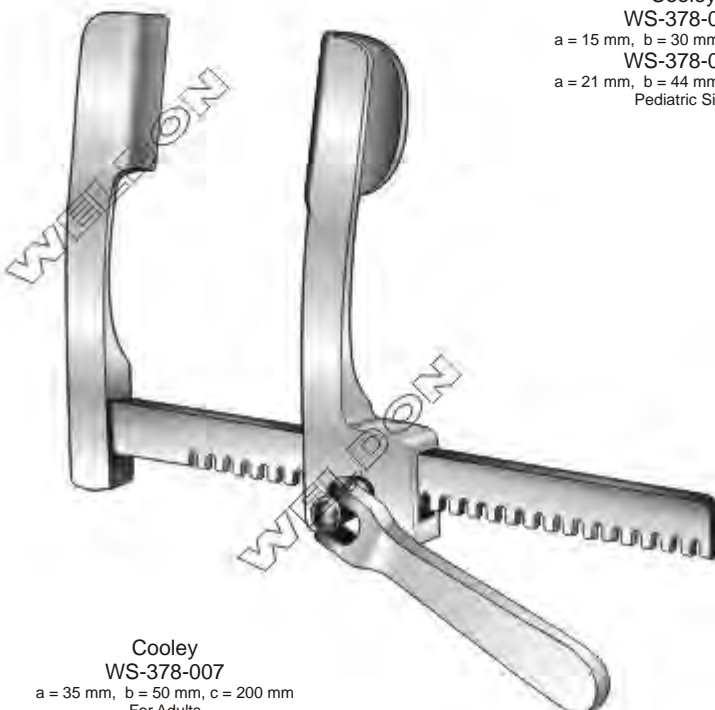

Cooley
WS-378-007
 a = 35 mm, b = 50 mm, c = 200 mm
 For Adults

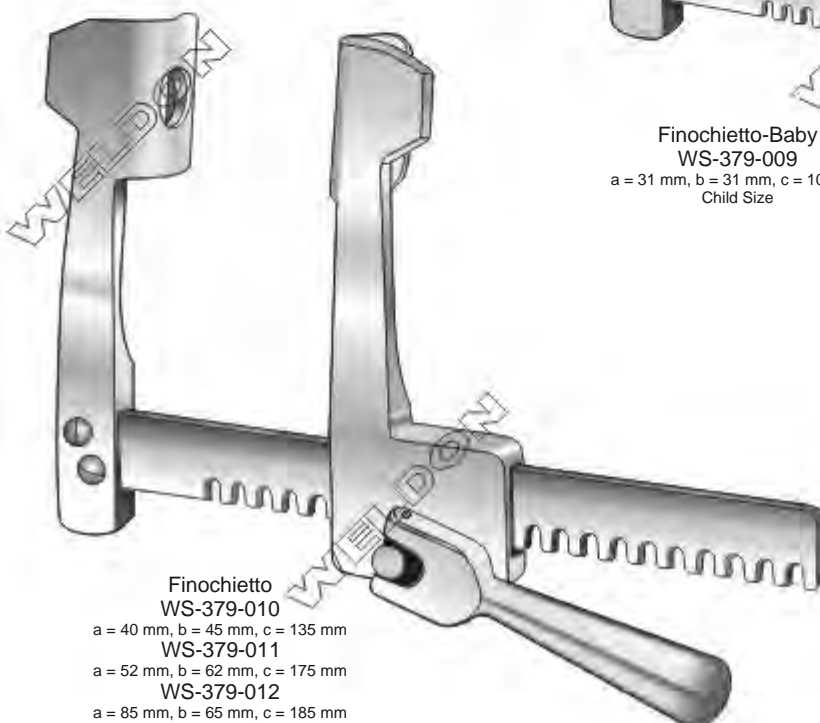
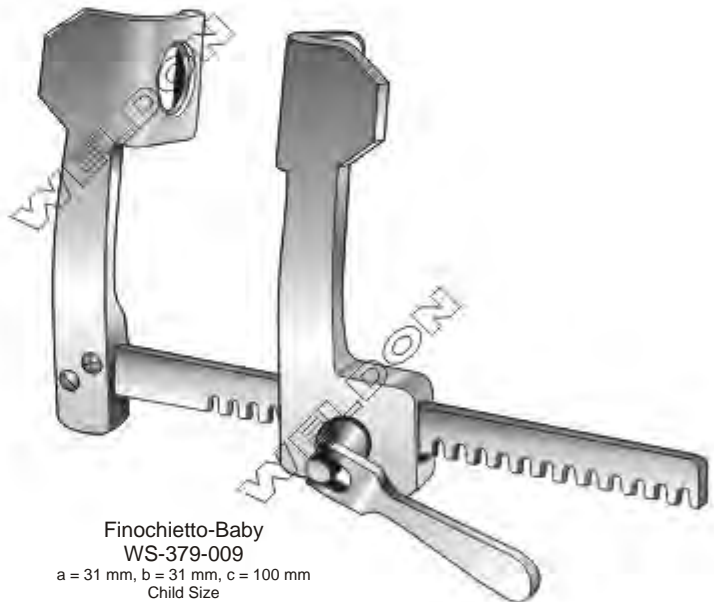
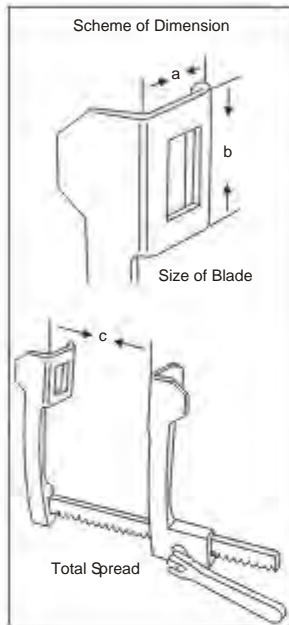

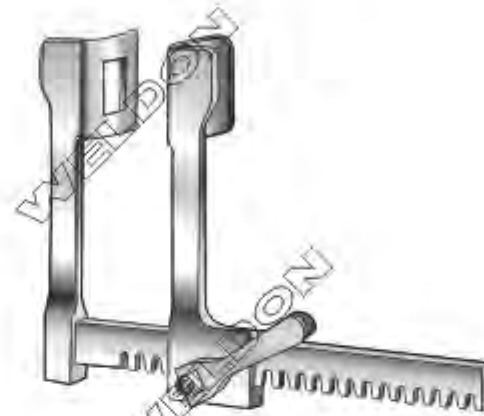
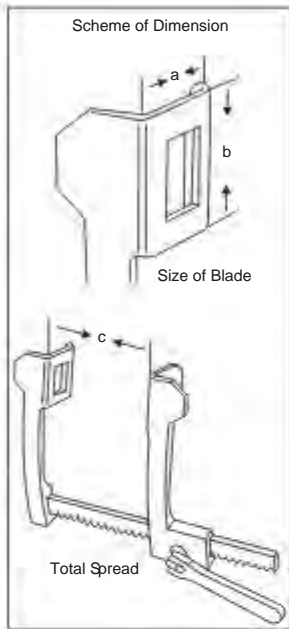

Finochietto
WS-380-013
a = 14 mm, b = 15 mm, c = 75 mm
Baby

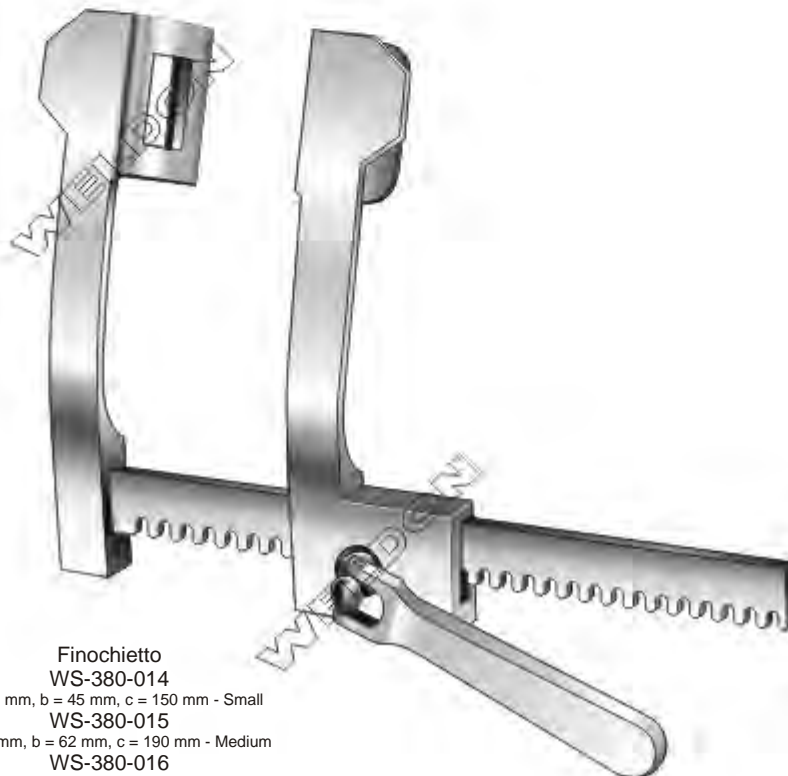

Finochietto
WS-380-014
a = 30 mm, b = 45 mm, c = 150 mm - Small
WS-380-015
a = 46 mm, b = 62 mm, c = 190 mm - Medium
WS-380-016
a = 80 mm, b = 65 mm, c = 250 mm - Large

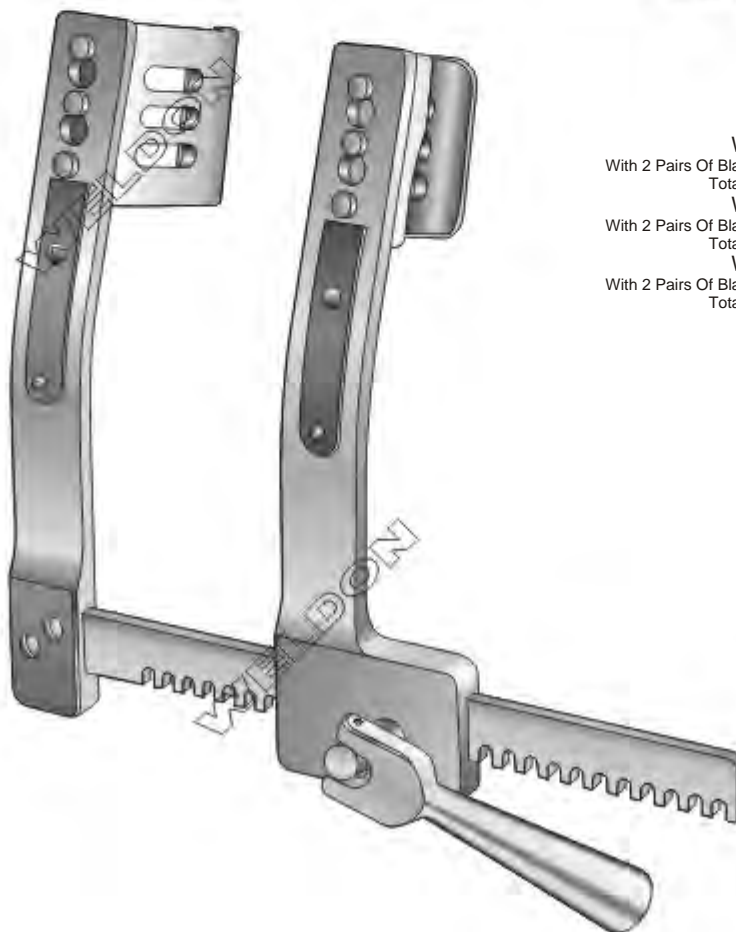
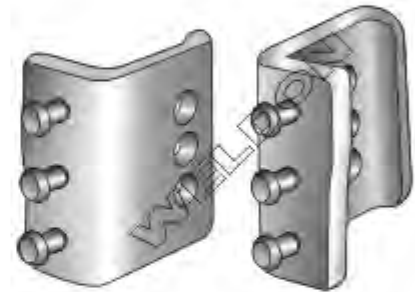
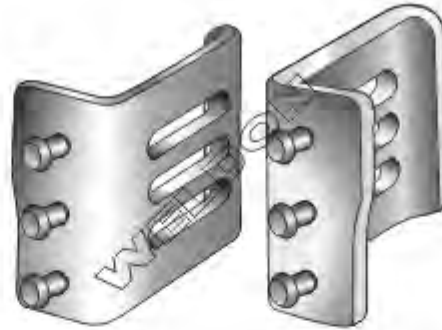
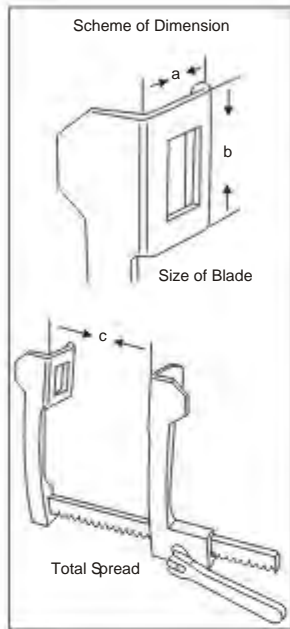

- Burford**
WS-381-017
 With 2 Pairs Of Blades = 47 X 62 mm & 65 X 62 mm
 Total Spread = 200 mm
WS-381-018
 With 2 Pairs Of Blades = 47 X 62 mm & 65 X 62 mm
 Total Spread = 260 mm
WS-381-019
 With 2 Pairs Of Blades = 47 X 62 mm & 65 X 62 mm
 Total Spread = 300 mm

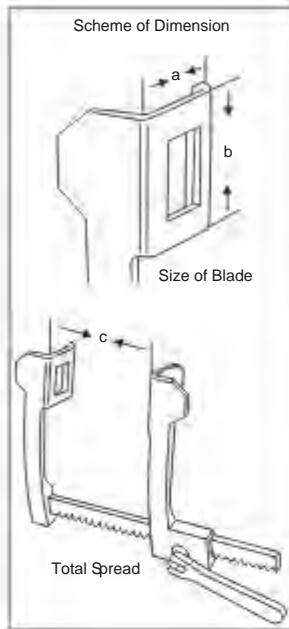

Castañeda
WS-382-020
Laterals Blades = 10.5 x 32 mm
Total Spread = 65 mm
For Babies



Castañeda
WS-382-021
Laterals Blades = 12 x 45 mm
Total Spread = 70 mm
For Infants



Castañeda
WS-382-022
Lateral Blades = 15 x 60 mm
Total Spread = 120 mm
For Infants

Scheme of Dimension

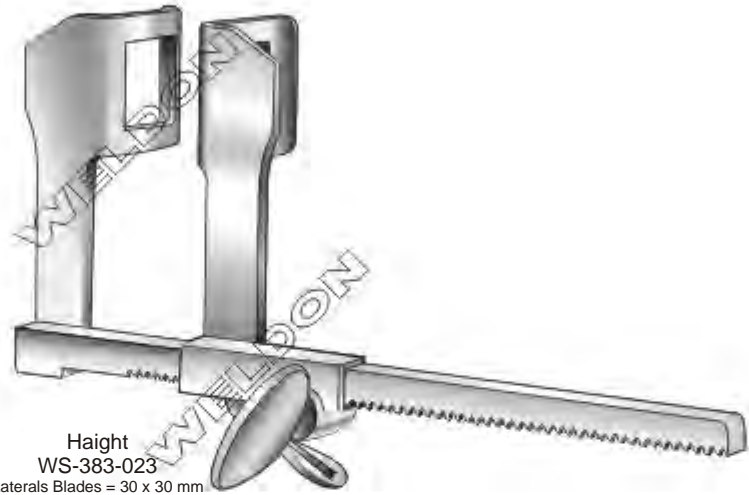
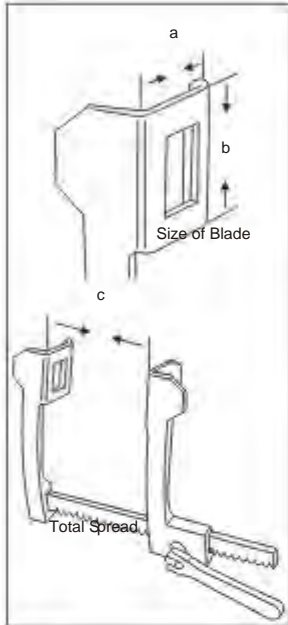

Haight
WS-383-023
Lateral Blades = 30 x 30 mm
Total Spread = 120 mm

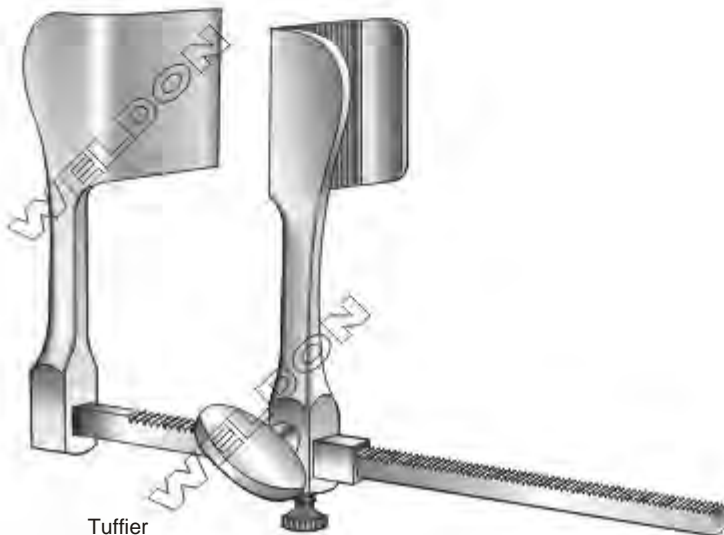

Tuffier
WS-383-024
Lateral Blades = 45 x 45 mm
Total Spread = 160 mm

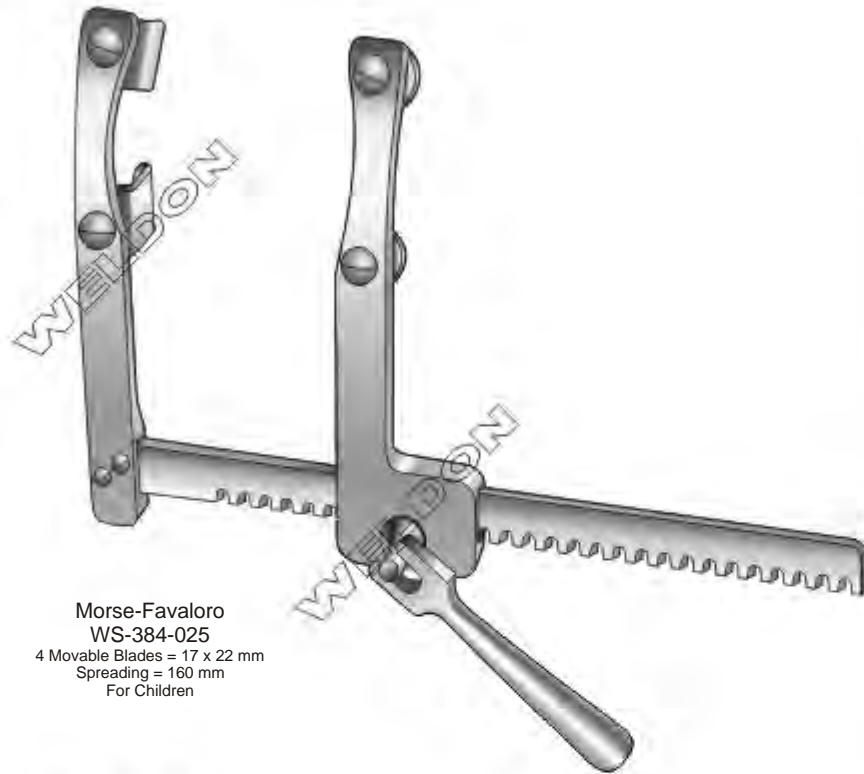

Morse-Favaloro
WS-384-025
 4 Movable Blades = 17 x 22 mm
 Spreading = 160 mm
 For Children

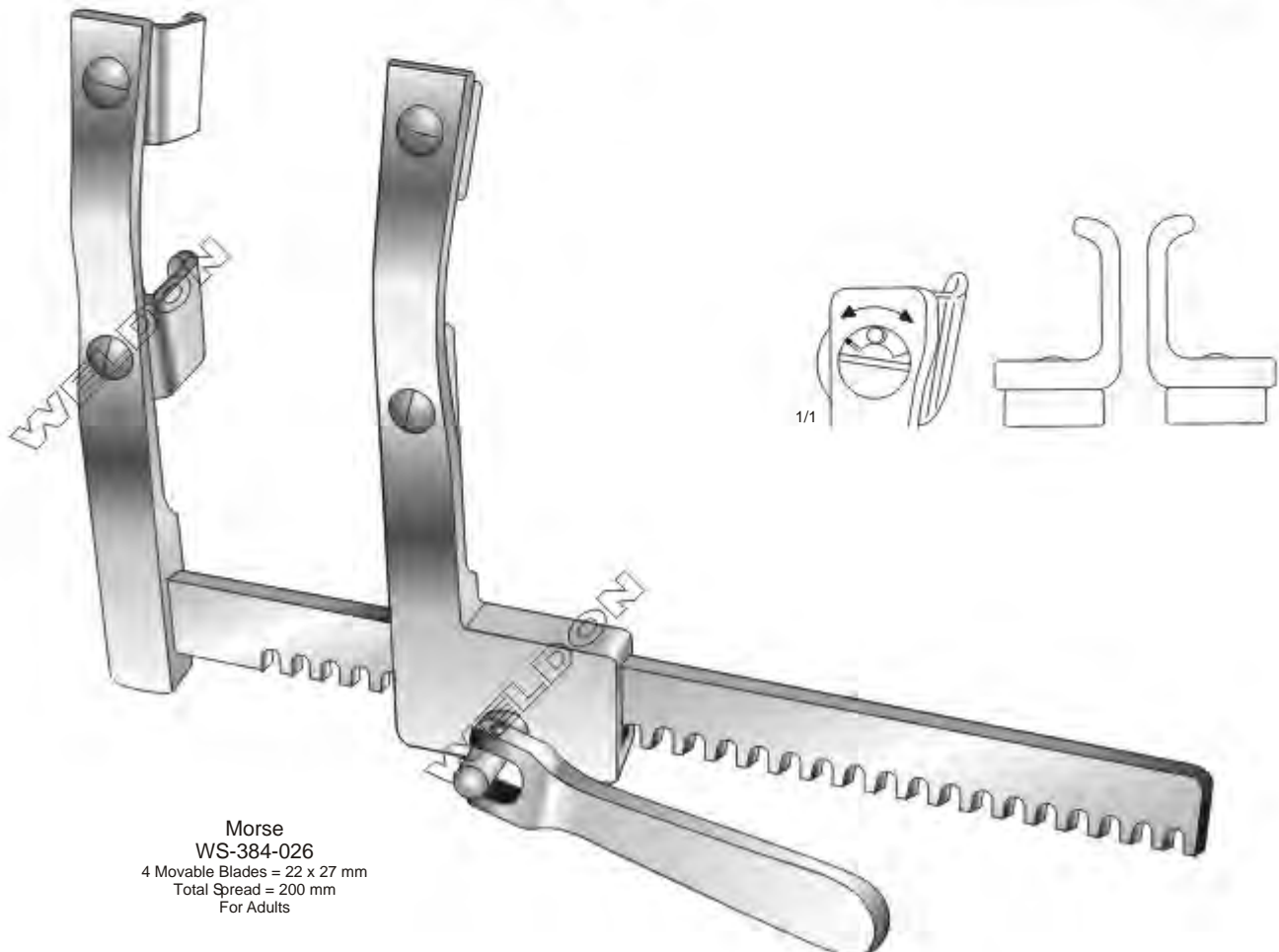
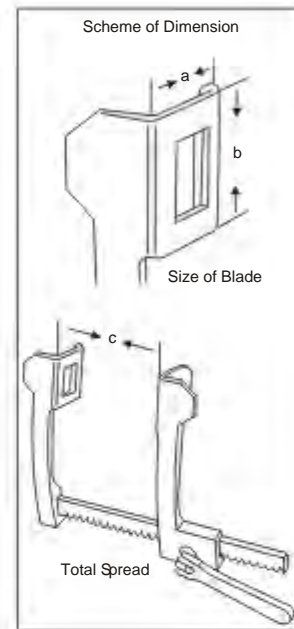

Morse
WS-384-026
 4 Movable Blades = 22 x 27 mm
 Total Spread = 200 mm
 For Adults